

**DEVELOPMENT AGREEMENT
(Jacksonville Naval Museum)**

THIS DEVELOPMENT AGREEMENT (“Agreement”), is entered into on this ___ day of _____, 2021 (“**Effective Date**”), by and between the **DOWNTOWN INVESTMENT AUTHORITY (“DIA”)** on behalf of the City of Jacksonville, a Florida municipal corporation (the “**City**”), and **JACKSONVILLE HISTORIC NAVAL SHIP ASSOCIATION, INC.**, a Florida non-profit corporation (the “**Association**”).

RECITALS

WHEREAS, the City owns certain uplands (the “**Uplands Area**”) and certain submerged lands (the “**Submerged Lands Area**”) more particularly described on **Exhibit A** and located along the north bank of the St. Johns River in downtown Jacksonville, Duval County, Florida, on property commonly known as the “**Shipyards**.” The Uplands Area, Pier 1 and Submerged Lands Area shall be collectively referred to herein as the “**Property**”; and

WHEREAS, the Association was organized in 2008 as a volunteer-based non-profit Florida corporation exempt from taxation under Section 501(c)(3) of the Internal Revenue Code, as amended, and was created to excite, inspire, educate and entertain the general public, to create a venue dedicated to the mission, memory and men of the Gearing-class destroyers, and to promote the role of the U.S. Navy in securing a free and safe world; and

WHEREAS, the Association has the opportunity to obtain ownership and possession of the retired naval vessel USS Orleck (DD-886) (the “**Vessel**”) by donation from the U.S. Navy and to relocate the Vessel to Jacksonville; and

WHEREAS, the Association plans to renovate and maintain the Vessel as a Downtown floating museum (“**Ship Museum**”), open to the public on the Submerged Lands Area, and to construct associated improvements on the Uplands Area and on Pier 1, to include an access walkway, restroom facilities, and a guest services area (collectively, the “**Project**”); and

WHEREAS, the Association’s operation of the Ship Museum will promote and operate educational and recreational programs and provide economic benefits to Jacksonville; and

WHEREAS, the DIA believes that the Project will be beneficial to the citizens of Jacksonville and the Jacksonville Downtown area and pursuant to Ordinance 2021-___-E, the DIA desires to assist the Association with the Project by entering into this Agreement with the Association and, contingent upon certain conditions precedent being met, granting the Association a ten (10) year license with no annual license fees, together with two (2) five (5) year renewal options upon the mutual agreement of the parties, to use the Property for the Project subject to the conditions contained herein.

NOW, THEREFORE, in consideration of the mutual promises and covenants, and for other good and valuable consideration, the adequacy and receipt of which is hereby acknowledged, the parties agree as follows:

1. RECITALS.

The above stated Recitals are true and correct and, by this reference, are made a part hereof and are incorporated herein.

2. AGREEMENT TERM.

This Agreement shall be effective for the period beginning on the Effective Date and ending one (1) year thereafter, unless sooner terminated by the parties pursuant to the provisions herein. This Agreement may be extended for a period of up to six (6) months at the sole discretion of the Chief Executive Officer of the DIA.

3. PROJECT SCOPE OF WORK.

The Association shall relocate, renovate and maintain the Vessel as a Downtown Ship Museum open to the public. The Vessel will be moored on the Submerged Lands Area in the location depicted on Exhibit A. The Association shall, at its sole cost and expense, construct associated upland improvements on the Property, to include an access walkway, a ticket booth, restroom facilities, and a guest services area (the “**Upland Improvements**”). The Association shall construct within the Submerged Lands Area and on Pier 1, the necessary improvements to accommodate the mooring of the Vessel in accordance with the Plans attached hereto as Exhibit B (the “**Mooring Improvements**”). The Upland Improvements and the Mooring Improvements are sometimes collectively referred to herein as the “**Improvements**”. The Mooring Improvements have been designed and approved and the plans attached reflect actual work to be performed. The Upland Improvements have not been fully designed and must obtain DDRB approval but shall be located entirely within the boundaries of the Upland Parcel. The Performance Schedule attached hereto as Exhibit C, and the Scope of Work for Mooring Improvements and Preliminary Scope of Work for Upland Improvements attached hereto as Exhibit D-1 and the Project Budget attached hereto as Exhibit D-2 are considered part of this Agreement and incorporated herein by this reference. The parties agree that the Scope of Work for the Mooring Improvements and Preliminary Scope of Work for Upland Improvements and Project Budget provide the estimated minimum amount of funding and work necessary for the Association to complete the Improvements. After executing the License Agreement, upon satisfaction of the Conditions Precedent (defined below), and prior to performing any construction or dredging on the Submerged Lands Area, the Association shall obtain the DIA’s approval of any changes to the plans and scope of work for the Mooring Improvements. Prior to commencement of any construction on the Uplands Parcel, the Association shall obtain DDRB approval of any improvements to be constructed thereon and DIA’s approval of the final plans for the Upland Improvements and final scope of work for the same which shall be attached hereto as Exhibit B-1.

4. PROPERTY EXAMINATION.

- A. Title and Survey. The Association, at its sole expense, shall obtain and deliver to the DIA a current ALTA survey of the **Property** (the “**Survey**”), certified to the DIA and the City for reliance thereon, and a title examination report showing all liens and encumbrances of record affecting the Property (“**Title Report**”). The Title Report shall be delivered to the DIA together with copies of all exception documents referenced

therein and shall be issued by a licensed title insurance company in Florida. If the Title Report or Survey discloses any defects in title or other matters with respect to the Property that in the DIA's sole discretion are unacceptable to the DIA or adverse to the Project ("**Title Defects**"), then the DIA shall deliver written notice to the Association within fifteen (15) days after the receipt of the last of the Title Report and the Survey. The Association, at its sole expense, in cooperation with the DIA, may cure or remove such Title Defects. If the Association is unsuccessful in removing the Title Defects within twenty (20) days of the DIA's notice of the Title Defects, the Association or the DIA may within ten (10) days thereafter terminate this Agreement.

- B. Environmental Conditions. The Association acknowledges that the Uplands Area and the Submerged Lands Area are currently subject to a Brownfields Site Rehabilitation Agreement ("**BSRA**"), Site ID #BF16000-1002, and a Florida Department of Environmental Protection Consent Order (OGC Case 96-2444) ("**Consent Order**"), copies of which have been provided to the Association. The Association shall comply with the BSRA and the Consent Order and any of the conditions of those agreements that affect the Property, including, but not limited to, non-disturbance of the site-wide, soils cap of two feet, except as allowed and governed by the Site-wide Cover Interim Remedial Action and Operation and Maintenance Plan dated August 12, 1998, and any amendments thereto. Further, the Association shall provide DIA and the City with written confirmation from FDEP that the improvements contemplated within the submerged lands area do not violate the BSRA nor require any special remedial action. The Association shall provide the DIA and City with immediate written notice of any communication from regulatory or grant authorities concerning contamination or remediation requirements. This Section 4.B shall be incorporated into the License Agreement terms.
- C. License Grant "As Is." Except as otherwise specifically set forth in this Agreement, it is understood and agreed that the DIA hereby disclaims all warranties or representations of any kind or character, express or implied, with respect to the Property, including but not limited to, warranties or representations as to matters of title, zoning, physical or environmental conditions, availability of access, ingress or egress, operating history, government approvals, governmental regulations or any other matter or thing relating to or affecting the Property. The Association represents that it has conducted or will conduct, prior to the DIA's grant of a license, such inspections and investigations of the Property, including, but not limited to, the physical and environmental conditions thereof, and shall rely upon same, and upon the effective date of the License Agreement shall assume the risk of adverse matters, including, but not limited to, adverse physical and environmental conditions, including the existence in or on the Property of hazardous materials, that may not have been revealed by inspections and investigations. The Association agrees that upon the effective date of the License Agreement the Property shall be licensed to the Association "**as is, where is**", with all faults, and there are no oral agreements, warranties or representations collateral to or affecting the Property by any of the parties hereto (except as set forth herein).

5. ASSOCIATION FUNDING OBLIGATION.

The Association shall provide the DIA with evidence of funding satisfactory to the DIA, in its sole discretion, in the amount of **TWO MILLION SIX HUNDRED FIFTY-SIX THOUSAND SEVEN HUNDRED NINETEEN and 00/100 U.S. Dollars (\$2,656,719.00)**, which is the amount necessary to complete the Project in accordance with the Plans for the Mooring Improvements, Preliminary Plans for the Upland Improvements, the Scope of Work and Project Budget (the “**Association Funding Obligation**”). Such evidence of funding may be in the form of actual donations received and on deposit, grant award letters, formal loan commitments from recognized lending institutions or an evergreen letter of credit or such other form as requested by, and satisfactory to, the DIA. The Association shall be listed as the grant award recipient on any grants received in connection with the Project and any such grant agreement terms shall not restrict the use of the Property without City’s prior written approval. Notwithstanding the foregoing, if the Association fails to obtain the Association Funding Obligation within six (6) months from the Effective Date, the DIA, at its sole option, may terminate this Agreement, and, after providing the Association with notice of the same, the parties shall have no further obligations hereunder except as expressly provided herein.

6. REMOVAL OF VESSEL AND IMPROVEMENTS.

By execution of this Agreement the Association acknowledges that the DIA may terminate the License Agreement upon ninety (90) days’ advanced written notice, without cause, in addition to the DIA and City’s rights to terminate the License Agreement for cause. The Association at its sole expense shall have sixty (60) days from the effective termination date as provided in the written notice to remove the Vessel and the Mooring Improvements as well as all Upland Improvements from the Property and restore the same to its condition as of commencement of the License, subject to the City’s right to retain such improvements as set forth in the License. The Association shall provide the DIA with certified estimated removal costs based on written quotes or other documentation as satisfactory to the DIA for review. The agreed upon estimated removal costs by the parties for the removal of the Vessel and the Improvements shall be increased by ten percent (10%) (the “**Estimated Removal Costs**”) and, as security for the Association’s obligation to remove the Vessel and the Improvements upon the termination of the License Agreement, the Association shall, prior to the execution of the License Agreement, provide to the City a check or wire transfer in the total amount of the Estimated Removal Costs for the City to hold in a City account. In the event the Association, upon termination of the License Agreement, fails to remove or relocate the Vessel and Improvements and restore the Property, the City shall have the right to utilize the trust account funds to effect the removal of the Vessel and the Improvements. In the event that the Estimated Removal Costs are not sufficient to cover the City’s costs to remove the Vessel and the Improvements, the Association shall within thirty (30) days of receipt of City’s written demand pay to the City any outstanding costs and reasonable expenses incurred by the City in connection with removing the Vessel and the Improvements. As set forth in the License Agreement, every fifth year during the term of the License Agreement, the Association will provide the DIA with a current cost estimate, certified by a licensed and insured towing company to be pre-approved by the City Engineer, for the costs to remove the Vessel and a current cost estimate to remove the Improvements approved by the City Engineer. In the event the City’s trust account funds are less than one hundred and ten percent (110%) of the most recent certified Estimated Removal Costs, the Association shall immediately increase the Estimated Removal Costs held in the trust account to account for the

difference. The Association's obligation in this Section 6 shall survive the termination or expiration of this Agreement.

7. CONDITIONS PRECEDENT TO CITY LICENSE GRANT.

The DIA's grant of a license to the Association shall be contingent upon the Association providing the DIA with the following deliverables prior to the expiration of the Agreement term, and current within ninety (90) days of the commencement of the License (collectively, the "**Conditions Precedent**"):

- A. Evidence that the Association's Funding Obligation has been met pursuant to Section 5 above;
- B. Satisfaction or cure of any Title Defects in accordance with Section 4 above;
- C. Florida Department of Environmental Protection's (FDEP) written approval of the License Agreement or written confirmation from FDEP that no such approval is needed;
- D. FDEP's written approval of the Project activities in the form of a regulatory permit or written confirmation from FDEP that no such permit is needed;
- E. FDEP's written confirmation that none of the work performed on the Upland Parcel or submerged lands violates the BSRA or requires further remedial action;
- F. United States Coast Guard's (USCG) written approval of the Project activities and mooring of the Vessel as contemplated in the License Agreement or written confirmation from the USCG that no approval of the same is needed;
- G. United States Army Corps of Engineer's (ACOE) written approval of the Project activities in the form of a regulatory permit and/or dredging permits or written confirmation from ACOE that no such permit is needed;
- H. Certificates of Insurance evidencing the Association has met the insurance requirements contained in the License Agreement;
- I. Receipt by the City of the Estimated Removal Costs pursuant to Section 6 above;
- J. DDRB approval of the Upland Improvements;
- K. Approval by the DIA of the final plans for the Upland Improvements and a final scope of work for the Upland Improvements as well as any amendments to the Plans and Scope of Work for the Mooring Improvements, or the Final Project Budget;
- L. Two (2) original copies of the License Agreement executed by the Association;
- M. Association Board Resolution adopting the terms of this Development Agreement; and

N. Evidence of the Association's 501(c)(3) tax exempt status.

Upon the Association having satisfied the Conditions Precedent, the DIA shall provide the Association with written approval and confirmation of the same as soon as practicable (but no later than fifteen (15) business days from the DIA's receipt thereof). The DIA shall specify in such letter whether a Condition Precedent has not been sufficiently satisfied and, in order for the DIA to grant the license, the Association shall provide the DIA with such additional documentation as necessary to satisfy the outstanding Condition(s) Precedent.

8. CONDITIONS PRECEDENT TO DELIVERY OF VESSEL TO CITY OF JACKSONVILLE.

Prior to the initiation of the transport of the Vessel to the City, Association shall have satisfied the following conditions precedent thereto.

- A. Written evidence of the Association's ownership of the Vessel by certificate of title or such other documentation satisfactory to the DIA;
- B. Written evidence via certificate or certified statement from the contractor of record that the Vessel has been properly reconditioned and retrofitted;
- C. DIA, or its designees, shall have the authority to inspect the Vessel to verify that the Vessel has been properly reconditioned externally prior to the Vessel's transfer to Jacksonville. A certified shipyard will perform documented repairs to: ship hull, main deck and the entire superstructure IAW USCG and a certified Marine Surveyor inspection companies recommendations. All work is to confirm seaworthiness, appearance, and strict adherence to maintaining the ships original configuration. The USCG will certify the ship for transfer to Jacksonville and use as a permanently moored craft.

Upon the Association having satisfied the conditions precedent in this Section 8, the DIA shall provide the Association with written approval and confirmation of the same as soon as practicable (but no later than fifteen (15) business days from the DIA's receipt of all documentation required in this Section 8, as such time frame may be reasonably extended for the purposes of a DIA inspection of the Vessel). The DIA shall specify in such letter whether a condition precedent has not been sufficiently satisfied and the Association shall provide the DIA with such additional documentation as necessary to satisfy the condition precedent.

9. LICENSE GRANT.

- A. Limited Site Access. During the Agreement term the Association shall have limited access to the Property for the purpose of showing the Property to prospective donors, grantors, investors or lenders in connection with the Project. The limited access grant contained in this subsection 9.A. shall be revocable by the DIA at any time during the Agreement term upon default by the Association or the DIA's exercise of its termination rights herein.

B. License Agreement. At such time that the Association has satisfied the Conditions Precedent pursuant to Section 7 above, the DIA shall grant the Association a ten (10) year license, with two (2) five (5) year renewal options subject to the mutual agreement of the parties, in substantially the form attached hereto as Exhibit E (the “License Agreement”) permitting the Association to occupy the Property for the Project as provided herein. The DIA shall provide the Association with one (1) original executed copy of the License Agreement within fifteen (15) business days from the date the DIA provides written approval and confirmation to the Association that the Conditions Precedent have been met pursuant to Section 7 above.

10. TERMINATION AND DEFAULT.

A. DIA Termination. The DIA may, by written notice to the Association, terminate this Agreement in any of the following circumstances below:

- i. If the Association fails to satisfy the Conditions Precedent within the time specified herein;
- ii. If the DIA or the City enters into a redevelopment agreement with a third-party for any portion of the Property;
- iii. Upon the DIA’s determination that adverse environmental conditions exist on the Property; and
- iv. A breach of any provision of this Agreement;
- v. An event of default under Section 10.D below; or
- vi. For any other reason in the DIA’s sole discretion and without cause upon having provided the Association with ninety (90) days’ advance written notice of the same.

B. Association Termination. The Association may, by written notice to the DIA, terminate this Agreement prior to the DIA’s execution of the License Agreement. In such event, the DIA shall direct by written correspondence to the City that the Estimated Removal Costs be returned to the Association.

C. Notice of Termination. Termination notice shall be delivered by certified mail, return receipt requested, or by such other means of delivery provided herein with proof of delivery. Upon receipt of a notice of termination the parties shall have no further obligations hereunder except as expressly provided herein.

D. Additional Defaults. The occurrence of any one or more of the following events prior to the expiration of the term shall constitute an event of default hereunder: (i) a violation of any applicable and governing federal, state or local law, rule, regulation or policy with respect to the subject matter hereof; (ii) if any representation or warranty contained in this Agreement shall be false or misleading in any material respect; (iii) the application by the Association for, or consent to, the appointment of a receiver, trustee, liquidator or

custodian (or similar official) of its or all or a substantial part of its assets, or if any party shall be unable or admit in writing its inability to pay its debts as they mature, make a general assignment for the benefit of creditors, be adjudicated a bankrupt or insolvent, file a voluntary petition in bankruptcy or a petition or answer seeking reorganization or any arrangement with creditors or agrees to take advantage of any insolvency law, file an answer admitting the material allegations of a petition filed against it in any bankruptcy, reorganization or insolvency proceeding or if any corporate action shall be taken by it for any purpose of effecting any of the foregoing, or if any order, judgment or decree shall be entered by a court of competent jurisdiction approving a petition seeking reorganization or appointing a receiver, trustee, liquidator or custodian (or other similar official) of any party hereto or of all or a substantial part of its assets, and such other judgment or decree shall continue unstayed and in effect for a period of thirty (30) consecutive days; or (iv) an event of default of the Association under any other agreement or transaction between the Association and the DIA or the City. If an event of default shall occur under this Section 10.D. and remain uncured for a period of thirty (30) days, then City or DIA shall have the right to immediately terminate and cancel this Agreement by giving to the Association written notice of such termination and cancellation.

- E. Remedies. Each party shall have the right to prosecute any proceedings at law or in equity against any defaulting party hereto, or any other person, violating or attempting to violate or defaulting upon any of the provisions contained in this Agreement, and to recover damages for any such violation or default. Such rights shall include the right to restrain by injunction any violation or threatened violation by another of any of the terms, covenants or conditions of this Agreement, or to obtain a decree to compel performance of any such terms, covenants, or conditions, it being agreed that the remedy at law for a breach of any such term, covenant, or condition (except those, if any, requiring the payment of a liquidated sum) is not adequate. All of the remedies permitted or available to a party under this Agreement or at law or in equity shall be cumulative and not alternative, and invocation of any such right or remedy shall not constitute a waiver or election of remedies with respect to any other permitted or available right or remedy.

11. NOTICES.

Unless otherwise provided herein, any and all notices, which are permitted or required in this Agreement, shall be in writing and shall be duly delivered and given when personally served, or the next business day after such notice is sent by overnight delivery service by a nationally recognized courier such as Federal Express or UPS with delivery charges paid by the sender, or three (3) business days after such notice is mailed to the person at the address designated below. If notice is mailed, the same shall be mailed, postage prepaid, in the United States mail by certified or registered mail – return receipt requested. Failure to accept certified or registered mail shall be deemed a receipt thereof within ten (10) days after the first notice of delivery of the certified or registered mail. Any entity may change its address as designated herein by giving notice thereof as provided herein or such other address either party from time to time specifies in writing to the other.

If to the DIA: Downtown Investment Authority
117 West Duval Street, Suite 310
Jacksonville, Florida 32202
Attn: CEO

With a copy to: Office of General Counsel
Government Operations Dept.
117 West Duval Street, Suite 480
Jacksonville, Florida 32202
Attn: Division Chief

If to Association: Jacksonville Historic Naval Ship
Association, Inc.
2 Independent Drive, Suite 1414
Jacksonville, FL 32202
Attn: Justin Weakland

With a copy to: Abel Bean Law P.A.
100 N. Laura Street, Suite 501
Jacksonville, FL 32202
Attn: Daniel K. Bean

12. REPRESENTATIONS AND WARRANTIES BY ASSOCIATION.

Without limiting the representations, warranties and covenants of the Association set forth elsewhere in this Agreement, as a material inducement for the DIA to enter into this Agreement, the Association represents and warrants to the DIA (and unless otherwise specified, such representations, warranties and covenants are true as of the Effective Date and shall continue and be effective during the term of this Agreement as if continuously reiterated) that:

- A. The Association is a Florida non-profit corporation duly incorporated and validly existing under the laws of the State of Florida and is a corporation exempt from taxation under Section 501(c)(3) of the Internal Revenue Code, as amended. The Association is authorized to conduct business and is in good standing in the State of Florida. The Association has full power and authority (including the Association obtaining any and all required third party consents) to execute and deliver this Agreement and all documents contemplated hereby, to perform its obligations arising hereunder and thereunder, and that the Association's entering into this Agreement will not conflict with or result in a breach of any other agreement to which Association is a party. The individuals signing on behalf of the Association have full power and authority to do so and the Association shall promptly deliver to the DIA, upon request, all documents reasonably requested by the DIA to evidence such authority.

- B. The making, execution and delivery of this Agreement and the Association's performance of all obligations hereunder have been duly authorized and approved by the shareholders, members, partners, or Board of Directors (as the case may be) of the Association.
- C. This Agreement and all documents contemplated hereby each constitute a legal, valid and binding obligation of the Association, enforceable in accordance with their respective terms, assuming execution of the same by the DIA.
- D. This Agreement and all documents contemplated hereby do not and will not contravene any provision of the governing documents of the Association, any judgment, order, decree, writ or injunction to which the Association is bound, or any provision of any applicable law or regulation to which the Association is bound. The execution and delivery of this Agreement and all documents contemplated hereby, and performance of its obligations hereunder and thereunder will not result in a breach of or constitute a default under any agreement or require the consent from any third party.
- E. The Association and each of its contractors, subcontractors, materialmen, laborers and other persons performing any work relating to the Project or Improvements hold all necessary licenses, permits and authorizations required by all applicable governmental agencies and authorities as a condition to conduct business in the State of Florida and to perform work on the Property. The Association shall promptly deliver to the DIA, upon request, all documents reasonably requested by the DIA to evidence such licenses, permits, and authorizations.

13. MISCELLANEOUS.

- A. Amendments. This Agreement shall not be amended or modified in any way except by an instrument in writing executed by both parties hereto.
- B. Time is of the Essence; Force Majeure. TIME IS OF THE ESSENCE in the performance by any party of its obligations hereunder. If any date of significance hereunder falls upon a Saturday, Sunday, or legal holiday, such date shall be deemed moved forward to the next day which is not a Saturday, Sunday or legal holiday. Saturdays, Sundays and legal holidays shall not be considered business days. In the event either party shall be delayed or hindered in, or prevented from, the performance of any act (other than the payment of money) required hereunder by reason of strikes, lock-outs, labor troubles, protests, civil unrest, inability to procure materials, failure of power, restrictive governmental laws or regulations, riots, insurrection, epidemic, pandemic, adverse weather conditions, war or other reasons of a like nature not the fault of the party delayed in performing work or doing acts required under the terms of this Agreement (all of such reasons or causes referred to herein as "force majeure"), then performance of such acts shall be excused for the period of the delay, and the period within which the performance of such act may be required hereunder shall be extended by a period equivalent to the period of such delay.
- C. No Waiver. No waiver of any term of or obligation pursuant to this Agreement may occur or be enforced unless it is signed by both parties hereto. The failure or delay by

either party in asserting any of its rights or remedies as to any default hereunder shall not constitute a waiver of such default or any other default or of related rights or remedies.

- D. Cumulative Remedies. Except with respect to rights and remedies expressly declared to be exclusive in this Agreement, the rights and remedies of the parties hereto are cumulative, and the exercise by either party of one or more of such rights or remedies shall not preclude the exercise by it, at the same or different times, of any other rights or remedies for the same default or any other default by the other party.
- E. Severability. Except as expressly provided to the contrary herein, each section, part, term or provision of this Agreement shall be considered severable, and, if for any reason, any section, part, term or provision herein is determined to be invalid, contrary to or in conflict with any existing or future law, rule or regulation by a court or governmental agency having competent jurisdiction, such determination shall not impair the operation of or have any other affect on the remaining sections, parts, terms or provisions of this Agreement, which shall continue to be given full force and effect and bind the parties hereto, and such invalid sections, parts, terms or provisions shall deemed to be not a part of this Agreement.
- F. No Third Party Beneficiary. This Agreement and the rights and obligations of the parties hereto shall inure to the benefit of and be binding upon the parties hereto. This Agreement is for the sole and exclusive benefit of the parties hereto, and no third party is intended to or shall have any rights or benefits hereunder.
- G. Governing Law/Venue. The Association acknowledges, consents and agrees that all legal actions or proceedings arising out of or related to this Agreement shall lie exclusively in a state or federal court in Duval County, Florida. This Agreement shall be governed by, construed and enforced in accordance with the laws of the State of Florida.
- H. Further Assurances. The Association shall, upon request of the DIA: (i) promptly correct any defect, error or omission in this Agreement and any related documents; (ii) execute, acknowledge, deliver, procure, record or file such further instruments and do such further acts deemed necessary, desirable or proper by the DIA to carry out the purposes of this Agreement; (iii) execute, acknowledge, deliver, procure, file or record any documents or instruments deemed necessary, desirable or proper by the DIA to protect its rights against the rights or interests of third persons; and (iv) provide such certificates, documents, reports, information, affidavits and other instruments and do such further acts deemed necessary, desirable or proper by the DIA to carry out the purposes of this Agreement.
- I. Conflicting Provisions. Unless otherwise expressly provided herein, in the event of a conflict between any provisions of this Agreement and any attachment or exhibit attached to or referenced in this Agreement, the provisions of this Agreement shall govern to the extent of such conflict. All parties acknowledge and agree that they have had meaningful input into the terms and conditions contained in this Agreement. The Association acknowledges that it has had ample time to review this Agreement and related documents with counsel of its choice. Should any provision of this Agreement require judicial

interpretation, there shall be no presumption that the terms hereof shall be more strictly construed against either party.

- J. Captions and Headings. Captions and headings in this Agreement are for convenience of reference only and shall not affect the construction of this Agreement.
- K. Representations and Warranties. All of the Association's representations, warranties and other covenants set forth herein shall be deemed continuing in nature and shall survive the expiration or early termination of this Agreement.
- L. No Assignment. This Agreement and the rights and obligations herein may not be assigned, in whole or part, by either party without the prior written approval of both the Association and DIA and the approval of the Jacksonville City Council.
- M. Public Records and Sunshine Law. The Association must comply with any and all applicable federal, state and local laws, rules, regulations and ordinances, as the same exist and may be amended from time to time. Such laws, rules, regulations and ordinances shall include, but are not limited to, Chapter 119, Florida Statutes, (the Florida Public Records Law) and Section 286.011, Florida Statutes, (the Florida Sunshine Law). Such laws, rules, regulations and ordinances must also include, but are not limited to obtaining and maintaining all licenses and certifications that are required to perform the Project and Improvements contemplated in this Agreement, in the City of Jacksonville, State of Florida. If any of the obligations of this Agreement are to be performed by a subcontractor, the provisions of this Section shall be incorporated into and become a part of the subcontract.
- N. Counterparts. This Agreement may be executed in any number of counterparts and all of such counterparts taken together shall be deemed to constitute one and the same instrument.
- O. Entire Agreement. This Agreement constitutes the entire understanding and agreement between the parties hereto with respect to the subject matter hereof and supersedes all prior negotiations, representations, agreements and understandings, oral or written, between them with respect to such subject matter.
- P. Independent Contractor. Association shall act as an independent contractor, and not as an employee, agent, partner, joint venturer, representative or associate of the DIA or the City, in operating the aforementioned Improvements set forth in this Agreement. The Association shall be solely responsible for the means, methods, techniques, sequences and procedures utilized in the full performance of this Agreement.
- Q. No Personal Liability. No representation, statement, covenant, warranty, stipulation, obligation, or agreement contained herein shall be deemed to be a representation, statement, covenant, warranty, stipulation, obligation or agreement of any member, officer, employee or agent of the City, the DIA or Association in his or her individual capacity, and none of the forgoing persons shall be liable personally or be subject to any personal liability or accountability by reason of the execution or delivery thereof.

R. Exhibits. The Exhibits attached hereto are all incorporated herein by reference.

IN WITNESS WHEREOF, the parties hereto duly execute this Agreement as of the day and year first written above.

**ASSOCIATION:
JACKSONVILLE HISTORIC NAVAL SHIP
ASSOCIATION, INC.**, a Florida non-profit corporation

By: _____

Print Name: _____

Title: Its President

Dated: _____

[Signature page of City of Jacksonville to immediately follow this page.]

DIA:

DOWNTOWN INVESTMENT AUTHORITY
on behalf of the CITY OF JACKSONVILLE, a
Florida municipal corporation

By: _____
Lori Boyer, CEO

Dated: _____

FORM APPROVED:

By: _____
Office of General Counsel

GC-#1339972-v16-JHNSA_USS_Orleck_Development_Agreement.DOC

LIST OF EXHIBITS

EXHIBIT A	Property (Uplands Area, Pier 1 and Submerged Lands Area)
EXHIBIT B	Final Plans for Mooring Improvements, Preliminary Plans for Upland Improvements
EXHIBIT C	Performance Schedule
EXHIBIT D-1	Scope of Work
EXHIBIT D-2	Project Budget
EXHIBIT E	License Agreement

Exhibit A

Property Legal Description for Uplands Area and Submerged Lands Area

A portion of the City-owned property commonly known as the “Shipyards” generally located along the north bank of the St. Johns River at 750 East Bay Street in downtown Jacksonville, Duval County, Florida as shown in the attached survey.

An upland parcel 50' x 90' and including approximately 4500 Square feet. Said parcel is 50 feet deep measured from a point 30 feet off the current bulkhead (the width of the proposed Riverwalk) thus from the interior line of the proposed Riverwalk extending 50 feet toward Bay street and 90 feet in length parallel to the Riverwalk and Bulkhead. The parcel's western boundary is 83 feet from the easterly ROW line of Catherine Street and extends 90 feet west to east. The Uplands parcel is depicted below.

The Submerged lands consist of area parallel to and immediately adjacent to Pier1 that is 55 feet wide as measured perpendicular to Pier 1 and running form the bulkhead to the outward extent of the City submerged land adjacent to Pier which is approximately 480 feet.

Pier 1- The westernmost City pier with the property commonly known as the Shipyards.

Exhibit B

**Final Mooring Plans
Preliminary Upland Improvement Plans**

[To immediately follow this page.]

ORLECK PIER MODIFICATIONS SCOPE OF WORK JACKSONVILLE SHIPYARDS PIER 1

An inspection of the pier was performed in 2005 the deck, the piers and the cap were evaluated. The majority of Pier 1 is in good condition, although there are isolated areas in poor condition. The Scope of work associated with the permanent mooring modifications required to accommodate the USS Orleck involve the installation of three stand off dolphins from which there will be a 6-foot diameter foam filled Marine Fenders at each one. Each stand off Dolphin will consist of two steel pipe piles driven into the River Bottom and a steel frame erected between them. Additionally, 8 new 50 Ton Bollards will be installed on the pier itself at specific locations. Finally, an access bridge will be provided from a raised platform on land to the stern of the ship. The access bridge would go over the future extension of the Riverwalk without having to access pier 1.

(2005 Inspection report excerpt) The existing pier is approximately 50 feet wide and 700 feet long. The superstructure of Pier 1 is comprised of hollow core precast concrete slab panels with grouted joints spanning between reinforced cast-in-place concrete bent caps. Pile supported caps support both the bents and AASHTO girders that lay directly beneath gantry rail pockets. Generally, the top side of the deck is in fair to good condition. The crane rail pockets are now filled with vegetation and debris. The remainder of the surface is somewhat rough with minor spalling typical throughout. There are numerous penetrations in the west and east edge panels for utilities and mooring features. Moderate edge spalling of these panels is also typical. The underside of the deck exhibits multiple areas of minor to moderate delamination and spalling, with the most severe spalling occurring on or near the perimeter slabs. The AASHTO girders and pile caps are generally in good condition, with isolated spalls and exposed reinforcing steel. The bent caps typically exhibit significant deficiencies only at the west and east ends. Moderate spalling and exposed and corroded reinforcing are prevalent at the cap ends, particularly at the abandoned utility penetrations. The underwater inspection consisted of visual inspection of the piling. Each pile cap is supported by either four or six concrete piles, generally without significant deficiencies.



USS Orleck DD-886

Naval Museum



JACKSONVILLE

N A V A L M U S E U M

JAX SHIPYARD SITE IMPROVEMENT PLANS

USS ORLECK

Jax Shipyard



3822 010 Blaymesdowns Rd,
Suite 132
Jacksonville, Florida 32217
office: 904-434-4386
www.morales-ce.com
Certificate of Authorization No. 30712

REVISIONS

NO.	DATE	DESCRIPTION	REV.	CRD.

PROJECT MANAGER
PROJECT ENGINEER
PROJECT ARCHITECT
PROJECT SUPERVISOR
PROJECT INSPECTOR
PROJECT COORDINATOR
PROJECT CLERK

PROJECT NO. 2107
DATE 02/15/2017

Project Number: _____
Drawing Number: _____



3825.010 Baymeadows Rd, Suite 132 Jacksonville, Florida 32217 office: 904-434-4366 www.morales-ce.com Certificate of Authorization No. 30712

Table with 3 columns: NO., DATE, DESCRIPTION, REV., CRD.

GENERAL NOTES

Project Name: USS ORLECK, P.E. Project No.: 2017-001, Date: 02/01/2017, Scale: 1/4" = 1'-0"

Project Number: G-1

CONCRETE:

- 1. ALL CAST-IN-PLACE CONCRETE SHALL HAVE A MINIMUM 28-DAY COMPRESSIVE STRENGTH OF 4500 POUNDS PER SQUARE INCH.

STEEL:

- 1. ALL PIPE PILES SHALL BE 24% 1/2" THICK STEEL 75-0" LONG.
2. ALL PIPE BRACING SHALL BE 6% EXTRA STRONG PIPE.
3. ALL FENDER PANELS SHALL BE 15'-0" X 10'-0" 1" STEEL PLATE.
4. ALL DOLPHIN BRACING PLATES SHALL BE 10" X 20'-0" 3/4" STEEL PLATE
5. ALL DOLPHIN WALE BEAMS SHALL BE W18 X 60
6. ALL STEEL SHALL BE PAINTED AFTER INSTALLATION.

MAXIMUM FENDER THRUSTS (3, 6x12 SC FOAMS) - 84-KNOT WINDS (30-SECOND DURATION AT 10m STD HEIGHT) WIND FROM ALL DIRECTIONS AND DESIGN HIGH WATER (DHW) = +7.4 ft MLLW

Table with columns: Fender ID, D1, D2, D3, Thrust (Kips), Reaction (Kips), Rated Fender Reaction (Kips), Safety Factor

MAXIMUM BOLLARD LOADINGS - 84-KNOT WINDS (30-SECOND DURATION AT 10m STD HEIGHT) WIND FROM ALL DIRECTIONS AND DESIGN HIGH WATER (DHW) = +7.4 ft MLLW

Table with columns: Bollard ID, B1, B2, B3, B4, B5, B6, B7, B8, X-Force (Kips), Y-Force (Kips), Total Horiz Force (Kips), Vertical Force (Kips), Total Force (Kips), Bollard Safe Working Load (Kips), Ship Double Bitt Fixture SHL (Kips)

MAXIMUM LINE TENSIONS - 84-KNOT WINDS (30-SECOND DURATION AT 10m STD HEIGHT); VETS 296-5 SPLICED MBL = 165 KIPS WIND FROM ALL DIRECTIONS AND DESIGN HIGH WATER (DHW) = +7.4 ft MLLW

Table with columns: Two-Part Line ID, B1, B2, B3, B4, B5, B6, B7, B8, Minimum Total Line Length, Minimum Line Tension / Part (Kips), Maximum Line Tension / Part as % of MBL, Ship Double Bitt Fixture SHL (Kips)

GENERAL NOTES

- 1. THESE NOTES SUPPLEMENT THE SPECIFICATIONS FOR THIS CONTRACT. ADDITIONAL NOTES WILL BE FOUND ON SUBSEQUENT DRAWINGS OF THE CONTRACT PLANS AND SUCH NOTES, WHILE PERTAINING TO THE SPECIFIC DRAWINGS ON WHICH THEY ARE PLACED, ALSO SUPPLEMENT THE GENERAL NOTES PROVIDED HEREIN.
2. ALL ELEVATIONS SHOWN IN THE PLANS ARE BASED ON THE NORTH AMERICAN VERTICAL DATUM (NAVD) 1988.

DESIGN CRITERIA:

- 1. THE DOLPHINS ARE DESIGNED FOR A HORIZONTAL LOAD OF 186 KIPS.
2. MOORING BOLLARDS ARE DESIGNED FOR 50 TONS AND 75 TONS RESPECTIVELY.
3. WATER SURFACE ELEVATIONS ARE AS SHOWN BELOW.

Table with columns: DATUM NAVD 1988, ELEVATION, 100-YEAR FLOOD, MEAN HIGHER-HIGH WATER (MHHW), MEAN HIGH WATER (MHW), MEAN LOWER-LOW WATER (MLLW), MEAN LOWER-LOW WATER (MLLW)

ENVIRONMENTAL PROTECTION NOTES:

- 1. THE CONTRACTOR SHALL CONDUCT OPERATIONS TO THE SATISFACTION OF THE ENGINEER, AND SHALL TAKE ALL NECESSARY PRECAUTIONS TO PREVENT POLLUTION OF THE WATER AND OTHER FOREIGN MATERIAL. THE CONTRACTOR SHALL NOT RETURN DIRECTLY TO A WATER OR TO A DITCH OR DRAINAGE STRUCTURE, ANY WASTE WATER WHICH HAS BEEN USED FOR WASH PURPOSES OR OTHER SIMILAR ACTIVITY AND COULD CAUSE THE WATER TO BECOME POLLUTED WITH SAND, SILT, CEMENT, OIL, OR OTHER IMPURITIES.
2. THE CONTRACTOR SHALL COMPLY WITH ALL APPLICABLE LOCAL, STATE, AND FEDERAL ENVIRONMENTAL PROTECTION REGULATIONS THROUGHOUT THE COURSE OF THE WORK.

ENVIRONMENTAL NOTES:

- 1. AS REQUIRED BY FDEP ENVIRONMENTAL RECONSTRUCTION PERMIT
2. CONTRACTOR SHALL PROVIDE A SPILL PLAN BEFORE ANY CONSTRUCTION ACTIVITIES BEGIN

INDEX OF DRAWINGS

Table with columns: SHEET NO., SHEET TITLE

USS ORLECK

Jax Shipyard



3833 O.D. Blaymesteads Rd.
Suite 132
Jacksonville, Florida 32217
office: 904-434-4386
www.morales-ce.com
Certificate of Authorization No. 30712

NO.	DATE	DESCRIPTION	REV.	CRD.
-----	------	-------------	------	------

SHIPYARDS UPLAND SITE PLAN

Project Number	Project Name
10-000000-001-P.E.	USS ORLECK
10-000000-002-P.E.	USS ORLECK
10-000000-003-P.E.	USS ORLECK
10-000000-004-P.E.	USS ORLECK
10-000000-005-P.E.	USS ORLECK
10-000000-006-P.E.	USS ORLECK
10-000000-007-P.E.	USS ORLECK
10-000000-008-P.E.	USS ORLECK
10-000000-009-P.E.	USS ORLECK
10-000000-010-P.E.	USS ORLECK
10-000000-011-P.E.	USS ORLECK
10-000000-012-P.E.	USS ORLECK
10-000000-013-P.E.	USS ORLECK
10-000000-014-P.E.	USS ORLECK
10-000000-015-P.E.	USS ORLECK
10-000000-016-P.E.	USS ORLECK
10-000000-017-P.E.	USS ORLECK
10-000000-018-P.E.	USS ORLECK
10-000000-019-P.E.	USS ORLECK
10-000000-020-P.E.	USS ORLECK
10-000000-021-P.E.	USS ORLECK
10-000000-022-P.E.	USS ORLECK
10-000000-023-P.E.	USS ORLECK
10-000000-024-P.E.	USS ORLECK
10-000000-025-P.E.	USS ORLECK
10-000000-026-P.E.	USS ORLECK
10-000000-027-P.E.	USS ORLECK
10-000000-028-P.E.	USS ORLECK
10-000000-029-P.E.	USS ORLECK
10-000000-030-P.E.	USS ORLECK
10-000000-031-P.E.	USS ORLECK
10-000000-032-P.E.	USS ORLECK
10-000000-033-P.E.	USS ORLECK
10-000000-034-P.E.	USS ORLECK
10-000000-035-P.E.	USS ORLECK
10-000000-036-P.E.	USS ORLECK
10-000000-037-P.E.	USS ORLECK
10-000000-038-P.E.	USS ORLECK
10-000000-039-P.E.	USS ORLECK
10-000000-040-P.E.	USS ORLECK
10-000000-041-P.E.	USS ORLECK
10-000000-042-P.E.	USS ORLECK
10-000000-043-P.E.	USS ORLECK
10-000000-044-P.E.	USS ORLECK
10-000000-045-P.E.	USS ORLECK
10-000000-046-P.E.	USS ORLECK
10-000000-047-P.E.	USS ORLECK
10-000000-048-P.E.	USS ORLECK
10-000000-049-P.E.	USS ORLECK
10-000000-050-P.E.	USS ORLECK

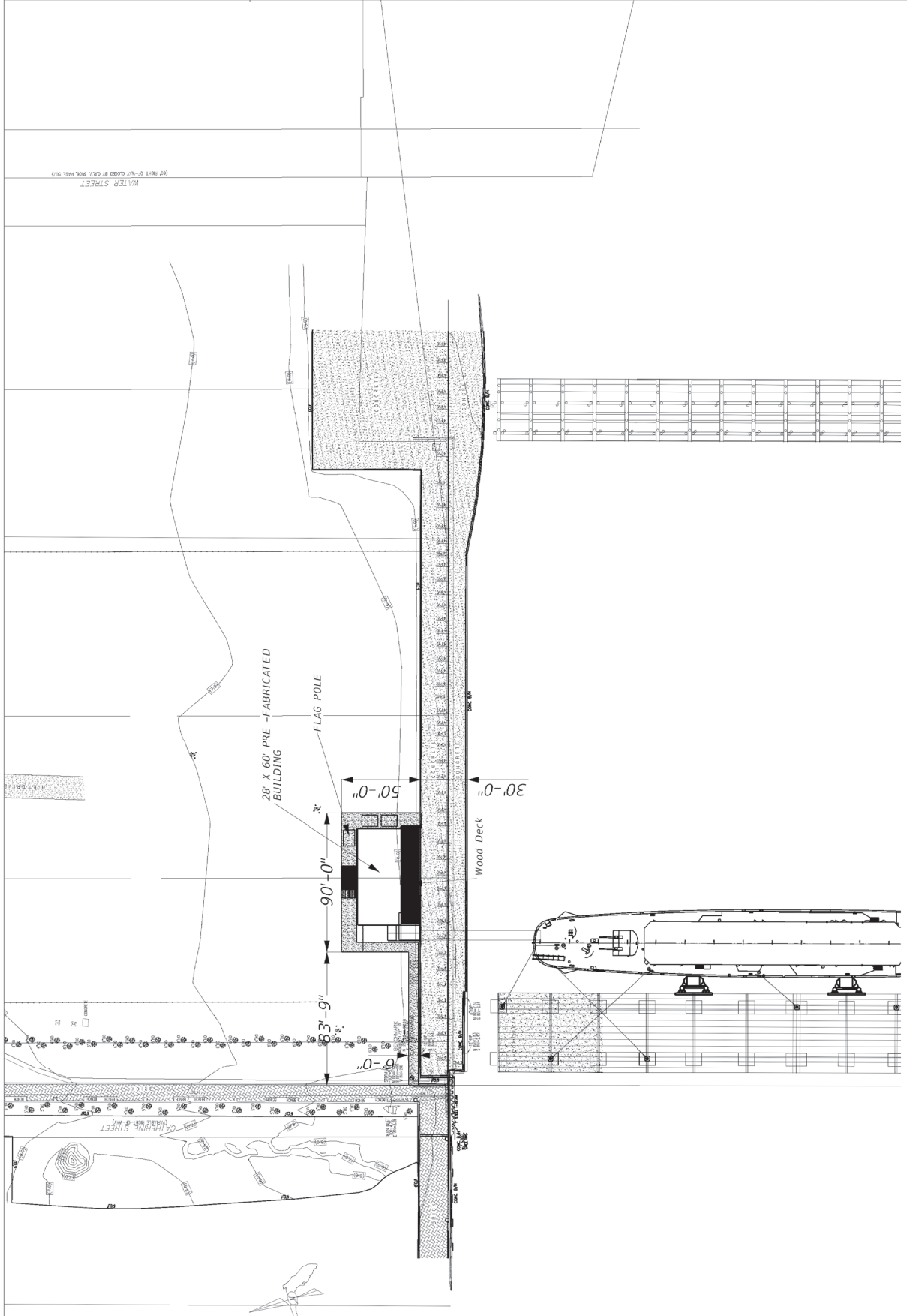

PIER 1

C-1

USS ORLECK

Jax Shipyard



3832 Old Blaymefields Rd.
Suite 132
Jacksonville, Florida 32217
office: 904-434-4386
www.morales-ce.com
Certificate of Authorization No. 30712

NO.	DATE	DESCRIPTION	REV.	ORD.

ORLECK ACCESS PLAN

Project Number	Project Name

Revision Number	Revision Description

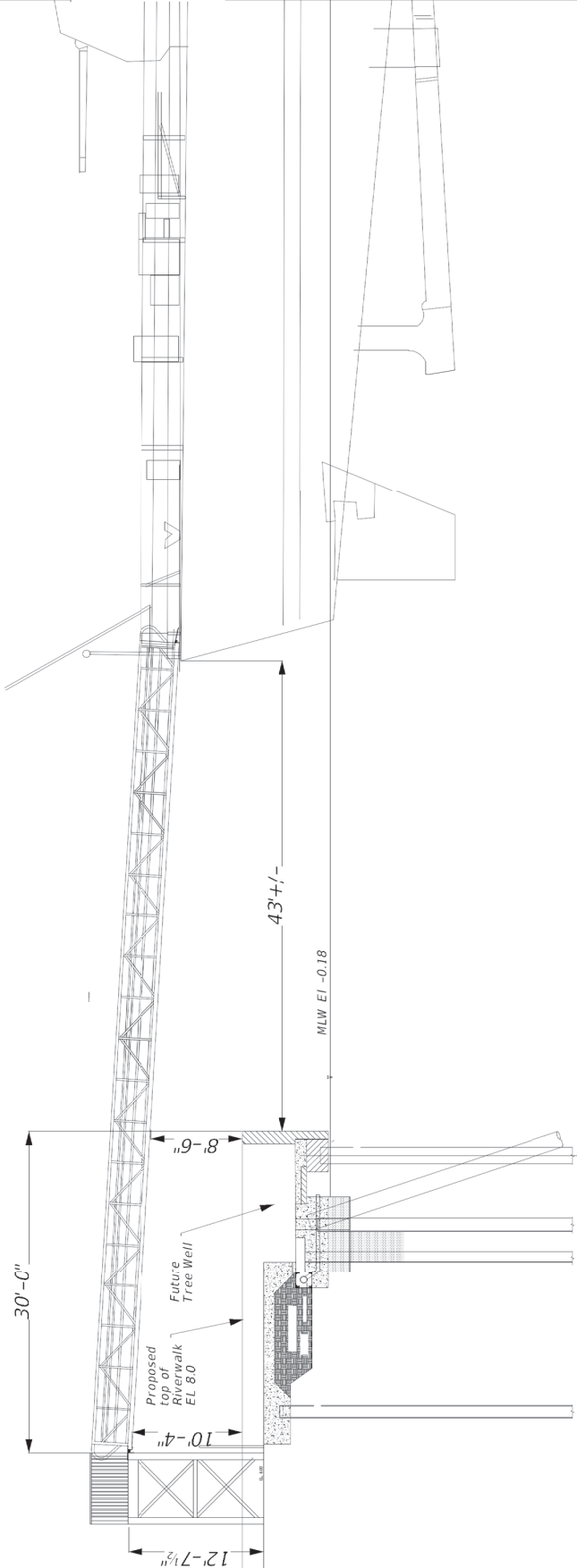

ELEVATION

USS ORLECK

Jax Shipyard



3832 010 Elymmeadows Rd.
 Suite 132
 Jacksonville, Florida 32217
 office: 904-434-4386
 www.morales-ce.com
 Certificate of Authorization No. 30712

NO.	DATE	DESCRIPTION	REV.	CRD.

SHIPYARDS
 SITE PLAN
 ORLECK
 & ADAMS

Project Manager	ESTIMATOR
PROJECT ENGINEER	DATE
PROJECT NUMBER	PIR NUMBER
CLIENT NAME	PIR NAME

S-1

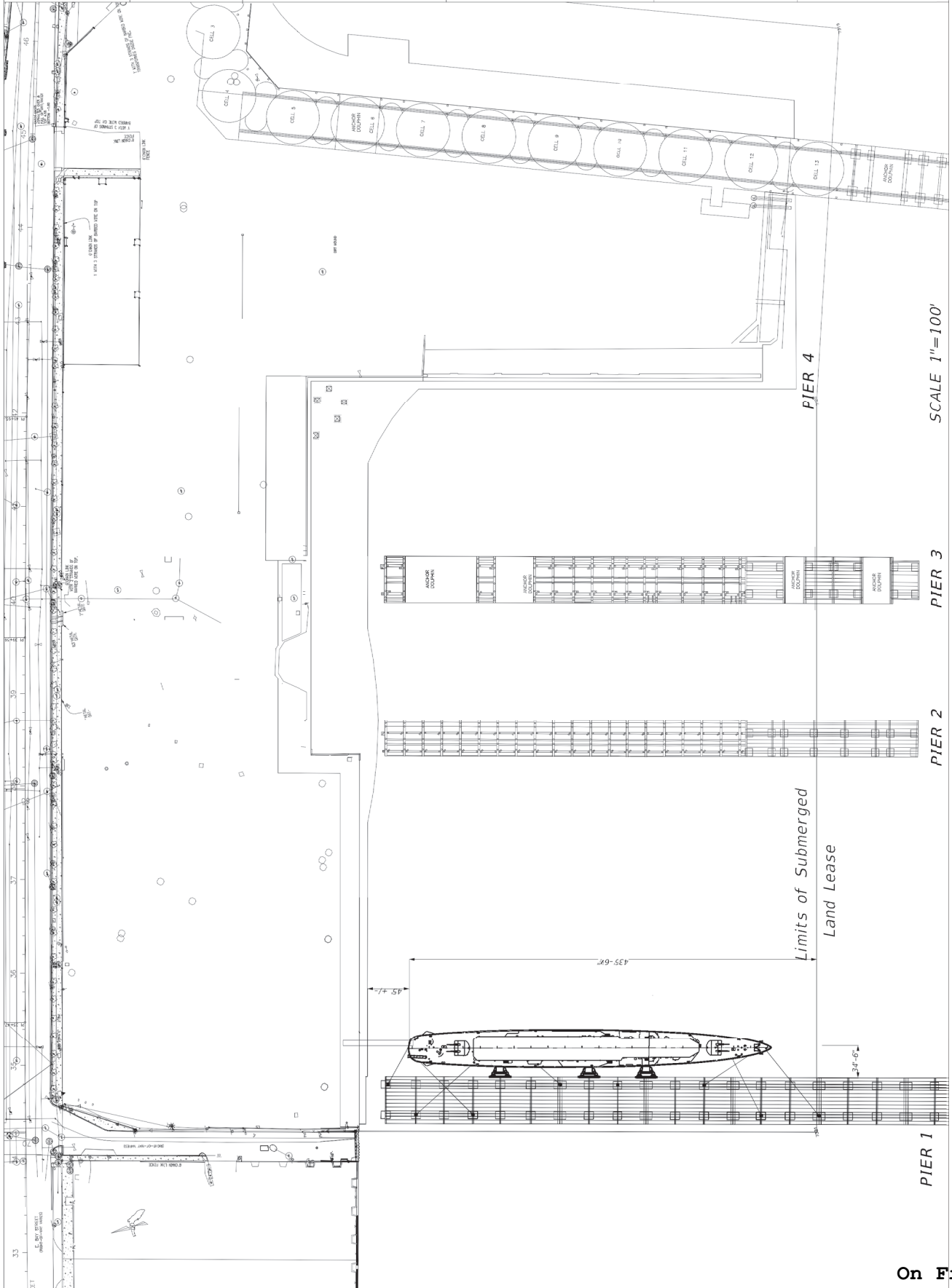

SCALE 1"=100'

PIER 3

PIER 2

PIER 1

Limits of Submerged
 Land Lease

PIER 4

CELL 13

CELL 12

CELL 11

CELL 10

CELL 9

CELL 8

CELL 7

CELL 6

CELL 5

CELL 4

CELL 3

USS ORLECK

Jax Shipyard



3832 O.D. Elymeadows Rd.
Suite 132
Jacksonville, Florida 32217
office: 904.434.4386
www.morales-ce.com
Certificate of Authorization No. 30712

NO.	DATE	DESCRIPTION	REV.	CRD.

FOUNDATION
LAYOUT PLAN

Project Manager	Project Engineer	Checker	Date

Mooring Bollard Locations: MSB 50 - B2, B3, B4, B5
MSB 75 - B1, B6, B7, B8

5-2

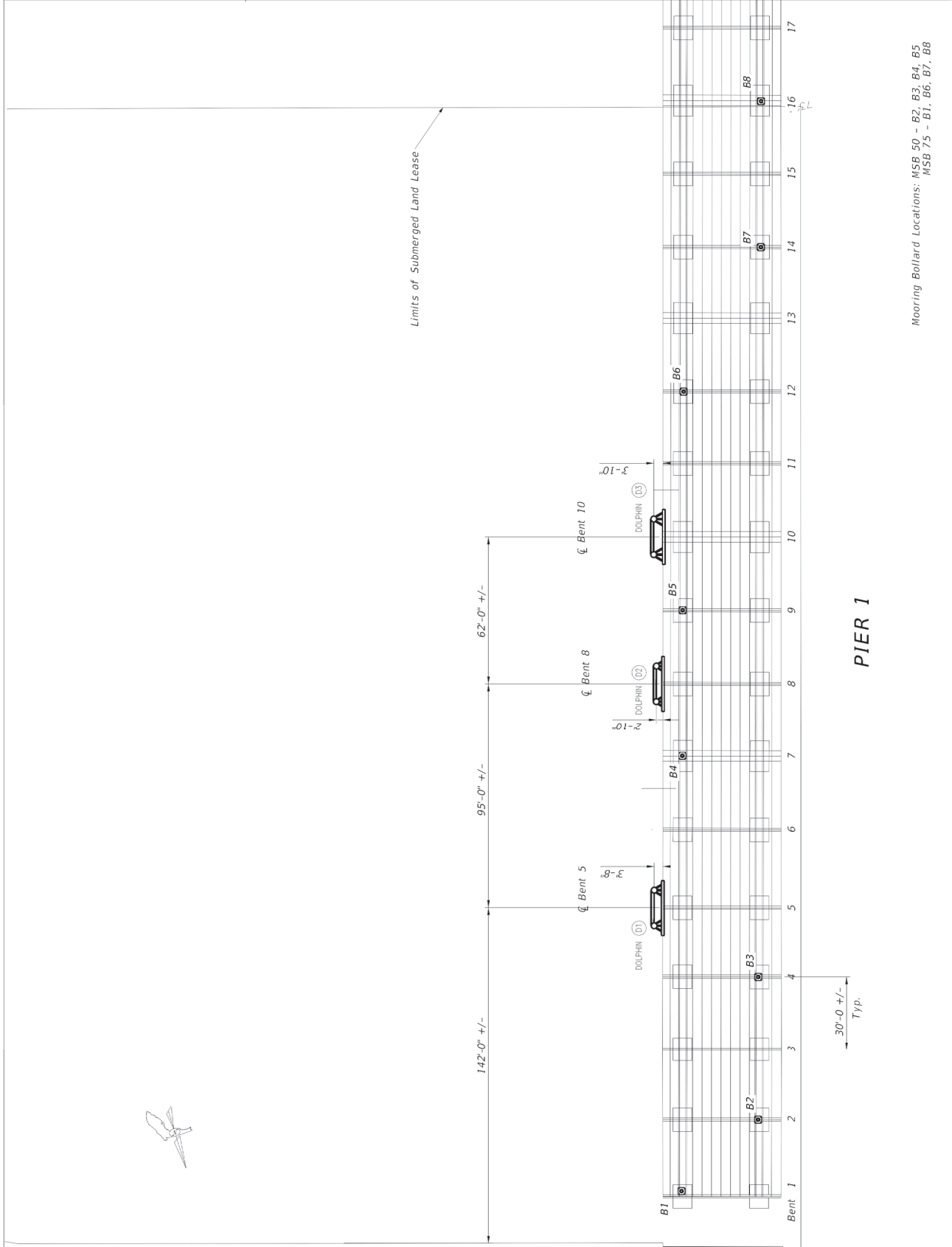

PIER 1

USS ORLECK

Jax Shipyard



3833 O.D. Blaymeadows Rd.
 Suite 132
 Jacksonville, Florida 32217
 office: 904-434-4386
 www.morales-ce.com
 Certificate of Authorization No. 30712

NO.	DATE	DESCRIPTION	REV.	CRD.

DOLPHIN D-1

NO.	DATE	DESCRIPTION	REV.	CRD.

Project Number	
Drawn Number	
Checked Number	
Scale	
Project Name	

S-4

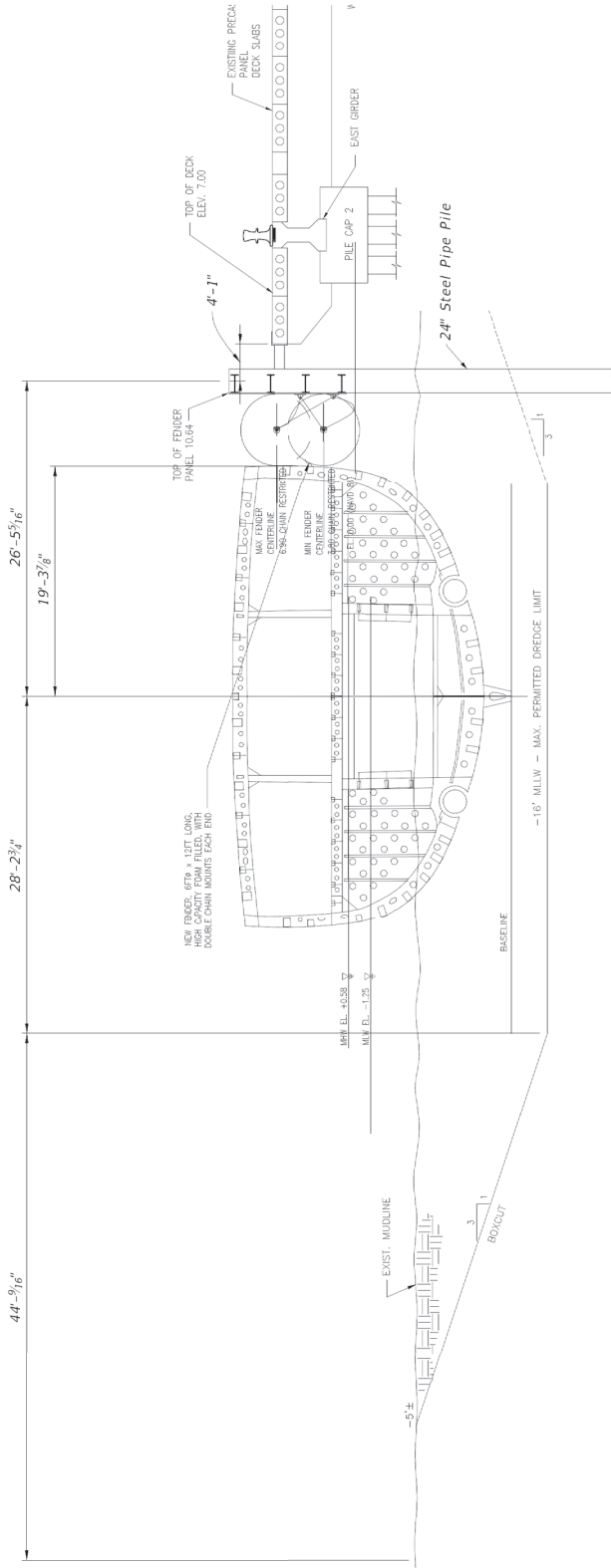

SHIP SECTION AT FRAME 148
 SCALE: 3/16" = 1'-0"

USS ORLECK

Jax Shipyard



3832.010 Blaymeadows Rd.
 Suite 132
 Jacksonville, Florida 32217
 office: 904.434-4386
 www.morales-ce.com
 Certificate of Authorization No. 30712

NO.	DATE	DESCRIPTION	REV.	CRD.

DOLPHIN D-2

Project Number	File Name

Change Number	

S-5

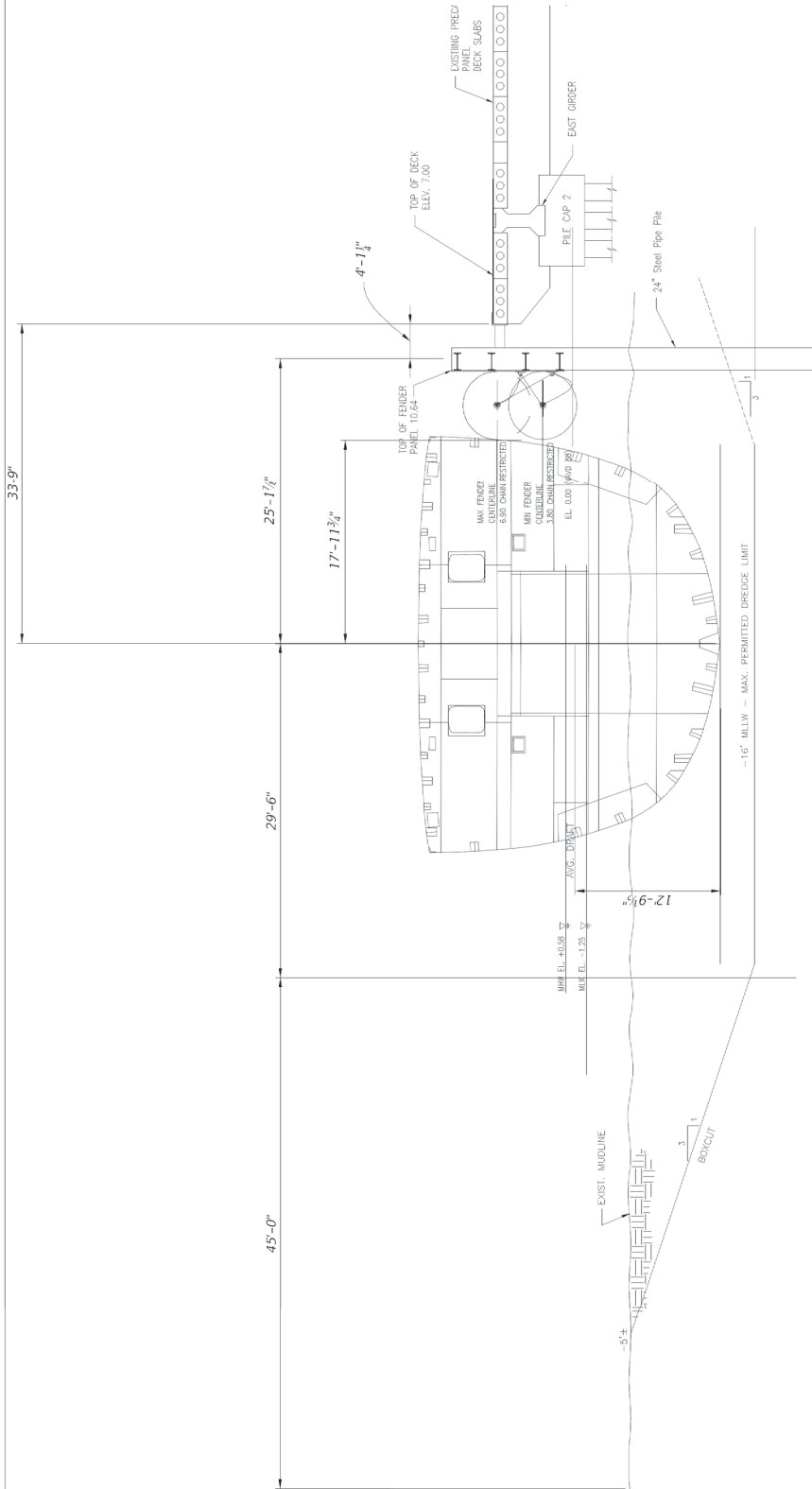

SHIP SECTION AT FRAME 83
 SCALE: 3/16" = 1'-0"

USS ORLECK

Jax Shipyard



3825 O.D. Blaymeadows Rd.
 Suite 132
 Jacksonville, Florida 32217
 office: 904.434.4386
 www.morales-ce.com
 Certificate of Authorization No. 30712

NO.	DATE	DESCRIPTION	REV.	CRD.

DOLPHIN D-3

Project Name:	
USS ORLECK D-3	
Client Name:	
NAVY	
Contract No.:	
Contract Description:	
Contract Start Date:	
Contract End Date:	
Contract Value:	
Contract Status:	

Project Number	Sheet Name
Drawing Number	Revision Number

S-6

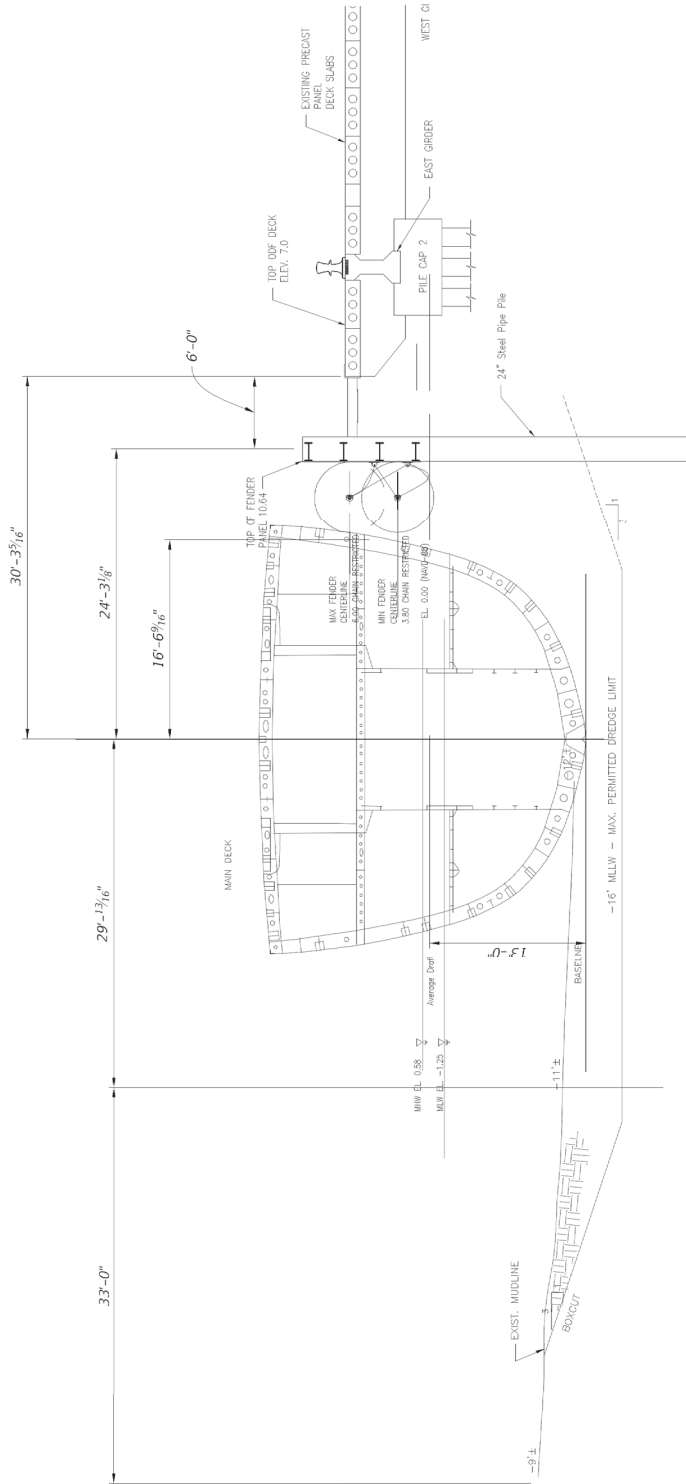

SHIP SECTION AT FRAME 68
 SCALE: 3/16" = 1'-0"

NO.	DATE	DESCRIPTION	REV.	CORD.

DOLPHIN DETAILS

PROJECT NUMBER	DATE	ISSUE

DESIGN NUMBER	DESIGNER

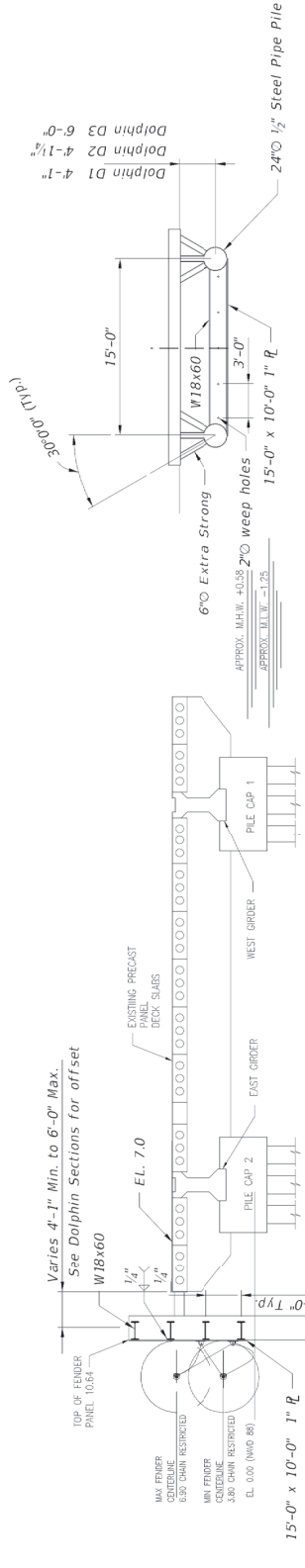

PLAN

SECTION A-A

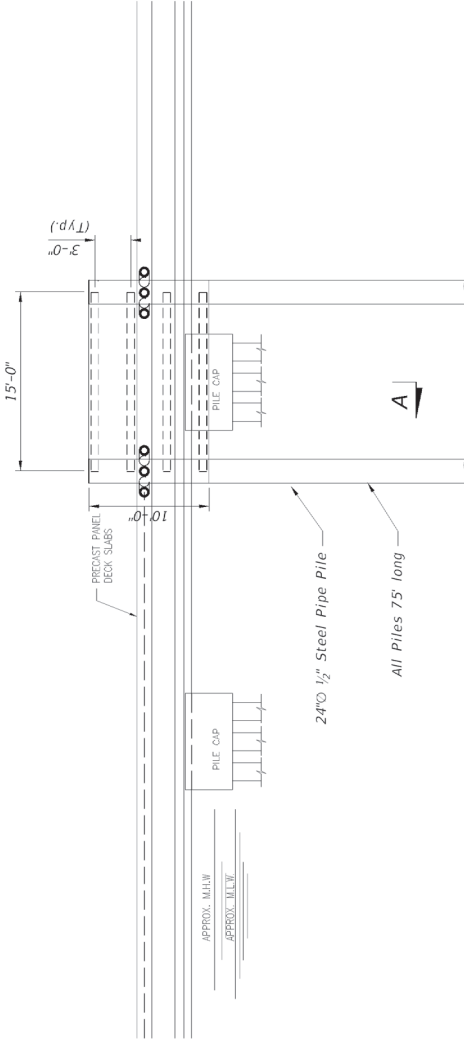

ELEVATION

USS ORLECK

Jax Shipyard



3832.010 Blaymefields Rd.
 Suite 132
 Jacksonville, Florida 32217
 office: 904-434-4386
 www.morales-ce.com
 Certificate of Authorization No. 30712

NO.	DATE	DESCRIPTION	REV.	CRD.

MOORING BOLLARDS DETAILS

Project Number:	10000000000000000000
Client:	USS ORLECK
Contract:	MOORING BOLLARDS
Drawn by:	
Checked by:	
Date:	
Scale:	
Project Name:	USS ORLECK
Sheet Number:	5-8

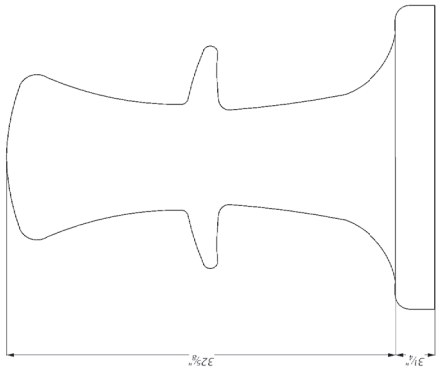

MSB 75

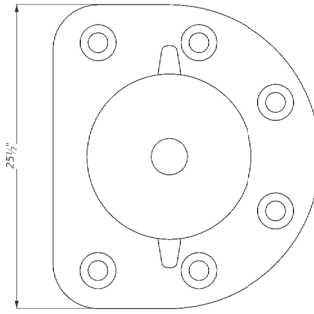

MSB 75

ANCHOR BOLTS 1 3/4" X 30" LONG.
 For Location see Sheet S-2

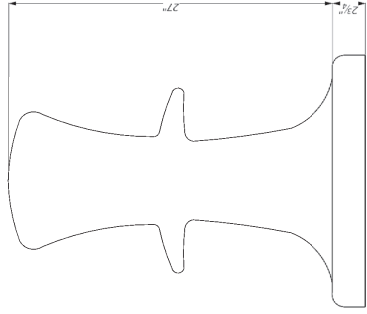

MSB 50

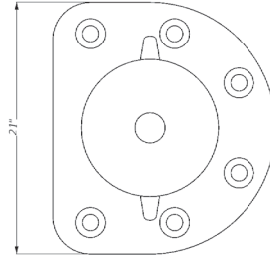

MSB 50

ANCHOR BOLTS 1 3/8" X 24" LONG
 For Location See Sheet S-2

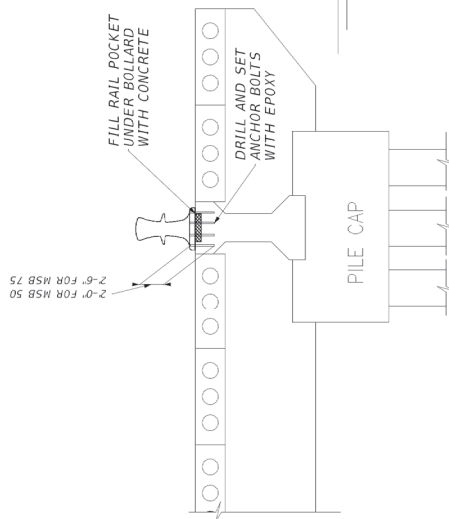

Exhibit C

Performance Schedule

The Association has one (1) year from the Effective Date of the RDA within which to meet all Conditions Precedent as set forth in the Agreement.

Within six (6) months from the effective date of the License agreement, Association shall have:

1. Completed all site work and completed the temporary upland museum/ticketing facility;
2. Relocated the Vessel to Pier One in accordance with the Agreement.

Within nine (9) months following the Effective Date of the License Agreement, the Association shall have completed construction of the access ramp to the Vessel and opened the Vessel for tours.

Exhibit D-1

Scope of Work for Mooring Improvements Preliminary Scope of Work for Upland Improvements

The upland improvements consist of a 28 x 60 one-story (15 feet in height) prefabricated temporary modular building which will house the ticket sales, offices, a museum gift shop, and restrooms consistent with the renderings approved by DDRB. Additional lot improvements will consist of decking, ADA ramp and access walkways, gangway to and from the ship and approved landscaping which will be in-line with the Riverwalk Plant Palette.

Exhibit D-2

Project Budget

[To immediately follow this page.]

USS ORLECK (DD-886) From Lake Charles to Port Arthur To Jacksonville Summary

Major Events		In-Kind/Gratis Donations	Florida Grant	Projected JHNSA Costs (not funded by FL grant)	FL Grant Funds Expended to date	FL Grant Funds Remaining	Remaining Costs For JHNSA
Shipyard Preps and On Site Repair & Restoration (John removed the obvious expenses that Adams would have had in Philly)	\$ 1,213,254	\$ -	\$ 449,130	\$ 764,124	\$ -	\$ 449,130	\$ 764,124
Tow & Tow preps	\$ 378,691	\$ -	\$ -	\$ 378,691	\$ -	\$ -	\$ 378,691
Pier 1 East Restoration	\$ 433,209	\$ -	\$ 419,930	\$ 13,279	\$ 139,997	\$ 279,933	\$ 13,279
Uplands Work For Access	\$ 230,100	\$ -	\$ 35,000	\$ 195,100	\$ -	\$ 35,000	\$ 195,100
Post Arrival Work To Open ORLECK as a Museum (Includes Tow Away Escrow)	\$ 401,465	\$ -	\$ 95,940	\$ 305,525	\$ 50,000	\$ 45,940	\$ 305,525
Total Costs	\$ 2,656,719	\$ -	\$ 1,000,000	\$ 1,656,719	\$ 189,997	\$ 810,003	\$ 1,656,719

Exhibit E

License Agreement

[To immediately follow this page.]

**LICENSE AGREEMENT
(Jacksonville Naval Museum)**

THIS LICENSE AGREEMENT (the “**License**”) is made and entered into this ___ day of _____, 202_ (the “**Effective Date**”), by and between the **DOWNTOWN INVESTMENT AUTHORITY** (“**DIA**”) on behalf of the CITY OF JACKSONVILLE, a Florida municipal corporation (the “**DIA**”), whose address is 117 West Duval Street, Suite 310, DIA, Florida 32202, and **JACKSONVILLE HISTORIC NAVAL SHIP ASSOCIATION, INC.**, a Florida non-profit corporation (“**JHNSA**”), whose address is 2 Independent Drive, Suite 144, Jacksonville, Florida 32202.

RECITALS

WHEREAS, the City owns certain submerged lands consisting of approximately 0.6 acres (the “**Submerged Lands Area**”), Pier 1 immediately adjacent to the Submerged Lands Area, as well as approximately 4,500 square feet of uplands in the vicinity of the Submerged Lands Area (the “**Uplands Area**”), each as more particularly described on **Exhibit A** and located along the north bank of the St. Johns River in downtown Jacksonville, Duval County, Florida. The Submerged Lands Area, Pier 1 and Uplands Area may also collectively be referred to herein as the “**Property**”; and

WHEREAS, JHNSA was organized in 2008 as a volunteer-based non-profit Florida corporation exempt from taxation under Section 501(c)(3) of the Internal Revenue Code, as amended, and was created to excite, inspire, educate and entertain the general public, to create a venue dedicated to the mission, memory and men of the Gearing-class destroyers and to promote the role of the U.S. Navy in securing a free and safe world; and

WHEREAS, JHNSA has the opportunity to obtain ownership and possession of the retired naval vessel USS Orleck (DD-886) (the “**Vessel**”) and relocate the Vessel to Jacksonville; and

WHEREAS, JHNSA plans to renovate, operate and maintain the Vessel as a Downtown floating museum (“**Ship Museum**”) open to the public on the Submerged Lands Area, secured to Pier 1, and JHNSA anticipates working with the DIA to provide, an access walkway, restroom facilities, and a guest services area to serve the Ship Museum to be located on the Uplands Area (collectively, the “**Project**”); and

WHEREAS, JHNSA’s operation of the Ship Museum as set forth herein will promote educational and recreational programs and provide economic benefits to Jacksonville; and

WHEREAS, the DIA believes the Project will be beneficial to the citizens of Jacksonville and the Jacksonville Downtown area; and

WHEREAS, subject to the terms of the Development Agreement dated _____ (the “**Agreement**”) between the DIA and JHNSA, JHNSA has met the Conditions Precedent (as defined

in the Agreement) and therefore, the parties desire to enter into a ten (10) year license with no annual license fees, together with two (2) five (5) year renewal options upon the mutual agreement of the parties, to use the Property for the Project as provided herein.

NOW, THEREFORE, for and in the consideration of the mutual and other good and valuable consideration, including, but not limited to, the covenants, conditions and terms hereof, the sufficiency and receipt of said good and valuable consideration being herewith acknowledged by the respective parties, the DIA and JHNSA stipulate and agree as follows:

1. Recitals. The recitals set forth above are accurate, correct and true and are incorporated herein by this reference.

2. Definitions. As used in this License, the words defined immediately below shall have the meaning stated next to same. Words imparting the singular number include the plural number and vice versa, and the male gender shall include the female gender and vice versa, unless the context clearly requires otherwise.

(a) “Approved Plans” shall mean the plans attached to the Agreement as Exhibit B for the Mooring Improvements together with the plans for Uplands Improvements submitted by JHNSA after the Effective Date of the Agreement but prior to the Effective Date of this License which have been approved by the DIA and DDRB. Such plans for the Uplands Improvements, which shall depict any construction on the Uplands Property, and be incorporated herein together with the final plans for the Mooring Improvements attached to the Agreement as of its Effective Date as **Exhibit B** to this License.

(b) “Approved Scope of Work” shall mean the scope of work submitted by JHNSA attached to the Agreement as Exhibit C together with any amendments thereto approved by DIA after the Effective Date of the Agreement but prior to the Effective Date of this License, which outlines the scope of work necessary to complete the Project, and to be incorporated herein as **Exhibit C**.

(c) “DIA” means the Downtown Investment Authority, a community redevelopment agency of the City of Jacksonville.

(d) “Governmental Requirement” means any permit, law, statute, code, rule, regulation, ordinance, order, judgment, decree, writ, injunction, certificate, license, authorization, or requirement of any governmental and/or regulatory national, state or local entity with jurisdiction over the DIA, City, JHNSA and/or the Property. Governmental Requirements shall include all applicable, relevant, or appropriate Florida Statutes and DIA Ordinances, including, without limitation, any regulation found in the Florida Administrative Code, and all Florida Statutes, DIA resolutions, City ordinances and regulations or rules now existing or in the future enacted, promulgated, adopted, entered, or issued, both within and outside the present contemplation of the respective parties to this transaction. Governmental Requirements shall include the BSRA and Consent Order, as defined in Section 7(d) below.

(e)

(f) “Hazardous Materials” means any flammable explosives, radioactive materials, hazardous materials, hazardous wastes, asbestos, radon, petroleum products, hazardous or toxic substances or related materials, including, without limitation, those defined in:

(i) The Comprehensive Environmental Response, Compensation and Liability Act of 1980, as amended (42 U.S.C. § 9601 et seq.);

(ii) The Hazardous Materials Transportation Act, as amended (42 U.S.C. § 1808 et seq.);

(iii) The Resource Conservation and Recovery Act of 1976, as amended (42U.S.C. § 6901 et seq.);

(iv) Regulations adopted and publications promulgated pursuant to the foregoing;

(v) Any other Governmental Requirement; and

(vi) Any other material, the use, release, disposal, or presence of which may result in liability under any Governmental Requirement or common law action.

(g) “Improvements” shall mean those improvements on the Submerged Lands Area and to the exterior of the Vessel once it is moored on the Submerged Lands Area and improvements to the finger pier in accordance with the Approved Plans, and improvements to the Uplands Area, including but not limited to ticket, access walkway and museum improvements.

(h) “JHNSA” shall have the meaning set forth in the preamble to this License.

(i) “License” means collectively this License and any and all exhibits hereto, including any amendments or addenda which may supplement, modify or amend the same, now or in the future.

(j) “License Term” means the initial term of this License, which is a period of ten (10) years commencing on _____, 202_, and terminating on _____, 20__, with two (2) five (5) year renewal options subject to the mutual agreement of the parties.

(k) “Performance Schedule” shall mean the performance schedule to be reviewed and approved by the DIA and incorporated into this License as **Exhibit D**.

(l) “Permitted Uses” means JHNSA’s use of the Property, which use shall be for the purposes set forth on **Exhibit E**, attached hereto and incorporated herein by this reference, all in compliance with the terms of this License and all Governmental Requirements.

(m) “Project Budget” shall mean the Project budget to be reviewed and approved

by the DIA and incorporated into this License as Exhibit C-2.

(n) “Project Sources of Uses and Funds” shall mean the Project sources of uses and funds to be reviewed and approved by the DIA and incorporated into this License as Exhibit E.

(o) “Property” shall have the meaning set forth in the Recitals to this License.

(p) “Project” means the construction, mooring, maintenance and operation of a floating museum within the retired naval vessel USS Orleck along a finger pier located within the Submerged Lands Area and associated improvements, including but not limited to an access walkway, restroom facilities, a ticket booth and guest services area to be located on the Uplands Area.

(q) “Vending” is defined as the exchange of goods, foodstuffs, and/or services for monetary gain or services-in-kind.

(r) “Vessel” means the retired naval vessel USS Orleck.

3. License. In consideration of the representations, agreements and covenants contained herein, the DIA shall grant a license to JHNSA for the initial term of ten (10) years, which term shall commence on _____, 202_, and continue until _____, 20_____, to use the Property for the Permitted Uses, together with the current improvements located thereon and all Improvements to be constructed or installed thereon by JHNSA during the License Term, in accordance with all of the provisions, covenants, conditions and terms herein. Upon mutual agreement of the parties, this License may be extended for two (2) additional periods of five (5) years under the same terms and conditions as set forth herein. Notice of JHNSA’s request for an additional term must be given to the DIA in writing at least one (1) year prior to the expiration of the then current term and the DIA shall provide JHNSA with written acceptance or denial of the same within fifteen (15) days after receipt of JHNSA’s written request.

4. License Fees. JHNSA shall not be charged any annual or monthly license fees during the License Term.

5. Taxes and Other Charges. JHNSA shall bear, pay and discharge, on or before the last day on which payment may be made without penalty or interest, all ad valorem real estate taxes or other taxes, if any, which shall or may during the License Term be charged, laid, levied, assessed, imposed, become payable and due, or become liens upon, or arise in connection with JHNSA’s use, occupancy or possession of the Property or any part thereof, and on the Vessel. The real estate taxes, if any, for the calendar year in which the License Term begins and ends shall be paid in full by JHNSA, whether or not the tax bill has been issued at the date the License Term has begun or terminated, and shall not be pro-rated between the respective parties.

6. Intentionally deleted.

7. Use of Property.

(a) The Property will be used as provided herein by JHNSA only for the Permitted Uses. No other use of the Property by JHNSA is permitted without the prior written consent of the DIA, which consent may be withheld in its sole and absolute discretion.

(b) JHNSA understands that it is the DIA's goal to ensure that the citizens of Jacksonville have maximum access to and use of the Ship Museum and the Property. JHNSA shall administer, maintain and operate the Property during reasonable hours consistent with JHNSA's purposes and uses as described herein. To facilitate use of the Property by the general public, and subject to the Governmental Requirements, JHNSA shall post the operational hours of the Ship Museum, including a schedule of activities and programs and specific days of the week and times of day the Ship Museum will be open to the general public.

(c) JHNSA agrees to comply, and be in compliance at all times, with Governmental Requirements imposed upon the Property and operation of the Ship Museum and shall not in any way subject the DIA to liability or exposure for failure to adhere to the same, and hereby indemnifies the DIA therefrom.

(d) JHNSA acknowledges and agrees that the Property is subject to certain provisions, conditions, terms and use restrictions which are imposed upon the Uplands Area, including, but not limited to, the Brownfields Site Rehabilitation Agreement ("**BSRA**"), Site ID #BF16000-1002 and a Florida Department of Environmental Protection Consent Order (OGC Case 96-2444) ("**Consent Order**"), a copy of which the DIA has provided to JHNSA, and other federal, state or local governmental and/or regulatory entities requiring that the use of the Uplands Area be in compliance with the provisions, conditions and terms of the said governmental/regulatory entities. JHNSA agrees to be in compliance at all times and to comply with the BSRA and the Consent Order and shall not in any way subject the DIA to liability or exposure for failure to adhere to such restrictions.

(e) JHNSA shall not discriminate against any person on the basis of race, creed, color, sex, religion, ethnic or national origin, age, marital status or disability in its use of the Property or operation of the Ship Museum.

(f) JHNSA shall comply with the DIA's Volunteer Background Screening Policy, completing Level II background and security reviews of all employees and volunteers who provide or perform services for JHNSA at the Property. Use or employment of any volunteer who has not successfully passed such screening policy will be deemed a breach of this License and may result in immediate termination of the License pursuant to Section 16 hereof. Further, JHNSA shall require any of its employees or volunteers participating in children's programs or activities submit to and successfully pass a Level 2 Background Screening, as contemplated in Section 435.04, Florida Statutes, or other applicable laws regarding children's programs and activities.

(g) JHNSA may sell alcohol during events held at the Ship Museum provided it has secured the necessary permits from the State of Florida Department of Business and Professional Regulation, special events permits and the insurance required by the DIA's Risk Management Division. In the event JHNSA chooses to serve alcohol, JHNSA assumes all risks, known, unknown

or reasonably foreseeable, which may be associated with such sales. JHNSA shall hold harmless, indemnify and defend the DIA and the DIA, including their respective directors, officers, employees, representatives and agents against any claim, action, loss, damage, injury, liability, cost or expense of whatsoever kind or nature (including, but not by way of limitation, attorney's fees or court costs) arising out of any injury, whether mental or corporeal, to persons, including death, or damage to property, arising out of or incidental to the sale of alcohol at the Property.

8. Improvements to Property, Personal Property.

(a) JHNSA shall commence construction of the Improvements in accordance with the Approved Plans, Approved Scope of Work, Project Budget, Project Sources and Uses of Funds and Performance Schedule (collectively, the "**Approved Documents**"). This License shall incorporate the Approved Plans, Approved Scope of Work, Project Budget, Project Sources and Uses of Funds and the Performance Schedule as Exhibits to this License.

(b) All additions, alterations changes or improvements made as part of the Project, including but not limited to the Improvements shall be made in conformance with the Approved Documents and with all applicable federal, state and municipal regulations, ordinances, codes and laws, including the Downtown Development Review Board design guidelines and requirements. JHNSA shall not make any further additions, alterations, changes or improvements in or to the Property or any part thereof without the prior written consent of the DIA, which consent may be withheld in the DIA's sole discretion. Menial maintenance shall not be included in this provision. All additions, alterations, changes or improvements made by JHNSA to the Property shall be constructed at JHNSA's sole expense and shall, upon the termination of this License for any reason, at the option of the DIA, become the property of the City or shall be removed at JHNSA's sole expense and the Property restored to its prior condition as of the Effective Date. JHNSA may place its personal property on or within the Property during the License Term from time to time at its discretion; however, all JHNSA personal property that may be on the Property during the License Term shall be thereon at JHNSA's sole risk.

(c) Any and all dredging necessary to accommodate the Vessel shall be the responsibility of JHNSA and JHNSA shall pay for all costs associated with the permitting, dredging and dredge disposal work within the Submerged Lands Area (except to the extent that such work is offered without charge to JHNSA). JHNSA shall acquire and comply with all necessary permits and approvals for the dredge work, including but not limited to the applicable permits listed on **Exhibit I** attached hereto ("**Applicable Permits**").

(d) Before starting and until the completion of the construction of the Improvements, the JHNSA shall comply with the indemnification and insurance requirements contained on **Exhibits G & H** attached hereto. Thereafter, JHNSA shall comply with the indemnification and insurance requirements as set forth on Exhibits __ and __ attached hereto.

(e) It is the intent of the parties that the DIA and the City shall be the intended beneficiary of all warranties relating to the construction of any Improvements (other than those on or in the Vessel), and JHNSA shall require all warranties to so designate the DIA and the City. Prior to substantial completion of any Improvement, JHNSA shall require all contractors to give

reasonable notice to the DIA and the City so that the DIA and the City may participate in final walk-through and punch list inspections. Prior to completion and close-out of the construction work, JHNSA shall require its contractors to give reasonable notice to the DIA and the City of all close-out training, including, but not limited to, start-up of equipment and operations and maintenance procedures in order that that DIA and the City may participate. JHNSA shall cause the contractors to deliver to the DIA and the City all warranties upon completion of the construction work.

(f) JHNSA shall require any contractor or contractors performing work, either as part of the Project or otherwise, to furnish a Construction 100% Performance and Payment Bond (“**Construction Bond**”) in an amount not less than the full amount of the contract price for completing the build-out of any Improvements, as surety for the faithful performance of the contract by the contractor, and for the payment of all persons performing labor and furnishing materials in connection with the work. JHNSA shall, before the commencement of any construction, furnish the DIA with evidence of the Construction Bond as outlined herein. If at any time during the continuance of the contract a surety on the contractor’s bond or bonds becomes irresponsible, the DIA shall have the right to request additional and sufficient sureties which JHNSA shall require the contractor to furnish within ten (10) days after receipt of written notice from the DIA to do so.

(g) Any additions, deletions or revisions to the Improvements, as set forth in the Approved Plans or any other approved designs and plans, shall require the prior written approval of the DIA.

(h) JHNSA shall obtain, at its own expense, any permits, changes to existing permits, architectural approvals and zoning approvals as may be required by federal, state and local laws and regulations for the construction of the Project and any additional improvements to the Property, and for JHNSA’s use of the Property.

(i) JHNSA shall if applicable obtain a certificate of occupancy for the Vessel or its equivalent prior to operating the Ship Museum and shall ensure that the Vessel and Improvements meet all applicable building codes and ordinances, including compliance with the Americans Disabilities Act of 1990, as applicable.

(j) It is understood and agreed between the parties that all Improvements to the Property upon termination or expiration of this License, shall, at the option of the DIA, become the property of the City, free and clear of all construction or other liens. JHNSA shall deliver to the DIA contractor(s)’ affidavits and waivers of lien from all those who supplied labor, material or services in connection with the construction of such Improvements, together with satisfactory proof of full payment of such.

(k) JHNSA agrees to comply, and to require any contractor, subcontractor or supplier to comply, with all applicable Governmental Requirements as well as the indemnification and insurance requirements applicable to the JHNSA hereunder.

(l) JHNSA acknowledges the existence of the BSRA and Consent Order and shall comply with any of the conditions of those agreements that affect the Property, including, but not limited to, non-disturbance of the site-wide, soils cap of two feet, except as allowed and

governed by the Site-wide Cover Interim Remedial Action and Operation and Maintenance Plan dated August 12, 1998, and any amendments thereto. JHNSA shall provide the DIA immediate written notice of any communication from regulatory or grant authorities concerning contamination or remediation requirements. By executing this License, the parties acknowledge that the Florida Department of Environmental Protection has given its written approval of the License as required by Paragraph 20 of the BSRA.

(m) JHNSA shall indemnify, defend and hold harmless the City, the DIA and their respective officers, employees, agents, invitees, guests and contractors from and against all claims, costs, losses and damages, including, but not limited to, all attorney's fees and all court costs, caused by, arising out of, or resulting from the construction of the Improvements, provided that any such claim, cost, loss or damage: (1) is attributable to bodily injury, sickness, disease, death or environmental remediation liability as referenced in Section 8(1) above, or to damage to or destruction of tangible property; and (2) is caused by acts or omissions of JHNSA or any of its contractors, subcontractors, suppliers, or any persons or organizations employed by any of them in the performance of or furnishing of the construction of any improvements. The provisions of this Section 8(m) shall survive the expiration or termination of this License.

(n) JHNSA and its contractors and subcontractors shall be responsible for damage to any area of the Property caused by construction of the Project.

9. Maintenance, Repairs and Utilities. JHNSA shall maintain and keep in good repair the Property, including, but not limited to, Ship Museum and all Improvements, restroom/concession facilities and JHNSA signage, and landscaping and mowing, if any. JHNSA shall be responsible for, and promptly pay, the installation charges for gas, electric, garbage, water, sewer and other charges or costs which may become payable and due during the License Term for the gas, electric, garbage, water, sewer and other services used by JHNSA at the Property. JHNSA shall be responsible for the installation and maintenance charges for any telephone facilities, computer facilities, or other communication facilities utilized by JHNSA at the Property. JHNSA shall pay, and be responsible for, the costs of all maintenance and repair associated with JHNSA's use of the Property. JHNSA shall at all times insure that the restroom facilities have an adequate supply of toilet paper, paper towels, soap and light bulbs. JHNSA shall be responsible at its sole cost and expense for the removal of trash from the Property.

10. Indemnification. JHNSA, its contractors, subcontractors, consultants and agents hereby agree to the indemnification provisions attached hereto as **Exhibit G** and incorporated herein by this reference.

11. Insurance. At all times during the License Term and any extensions thereto, JHNSA, its contractors, subcontractors, consultants and agents (as applicable) agree to obtain and maintain insurance in the forms and amounts provided in **Exhibit H** attached hereto and incorporated herein by this reference.

12. Compliance with Governmental Requirements. During the License Term, JHNSA shall comply with all Governmental Requirements that govern or affect the Property and arise out of JHNSA's use thereof. JHNSA shall notify the DIA of its violation of any Governmental

Requirement immediately after JHNSA's knowledge thereof, and JHNSA shall diligently and prudently take requisite action to correct any violations of Governmental Requirements which arise out of JHNSA's use of the Property as soon as reasonably possible after the discovery of same. JHNSA shall assure the DIA from time to time, by written certification, that JHNSA and the Property are in compliance with all Governmental Requirements affecting same.

13. Title to Property. Title to the Property shall remain vested with the City, subject to the covenants, conditions and terms of this License and JHNSA shall have no interest in the title to the Property but shall only have a license interest thereto. JHNSA shall accept the Property "as is". Any improvements made to the Property shall be vested with the City, which shall have the title thereto, subject to the covenants, conditions and terms of this License; however, no furnishings, furniture, equipment or other personal property installed or constructed by JHNSA on or within the Property shall be the City's property, but shall be the property of JHNSA. JHNSA shall have control of the Property subject to the covenants, conditions and terms of this License, but the City shall always remain vested with title to the Property and in control thereof to ensure that neither JHNSA nor any other entity shall have the authority or right to violate Governmental Requirements affecting the Property and the utilization thereof.

14. Destruction or Damage. In the event the Property or any part thereof is destroyed or damaged from any casualty, JHNSA shall, to the extent of available insurance proceeds, repair the damage and restore the Property to the extent reasonable and practical under the circumstances then existing.

15. Hazardous Materials.

(a) Except for cleaning supplies and other maintenance supplies (such as paint) in quantities suitable for consumer use, JHNSA shall not knowingly use, handle, store or permit the use, handling or storage of Hazardous Materials on the Property. JHNSA shall not dispose of or permit or allow the disposal, leakage, spillage or discharge on or upon the Property of any Hazardous Material. If any Hazardous Material should be used, handled or stored (except in accordance with this Section) or if any Hazardous Material is disposed of or permitted to leak, spill or discharge on or upon the Property by accident or otherwise, JHNSA shall provide immediate written notice thereof to the DIA and JHNSA shall immediately commence and diligently pursue the removal of any such Hazardous Material and JHNSA shall remediate, clean and restore the Hazardous Material area in accordance with all applicable Governmental Requirements, and pay all fines, fees, assessments and penalties arising therefrom. JHNSA shall furnish to the DIA, periodically at the DIA's request, certification that JHNSA is in compliance with the provisions of this Section.

(b) JHNSA shall provide written notice to the DIA within three (3) days of:

(i) any change in JHNSA's utilization and operation of the Property involving the use, handling or storage of Hazardous Materials;

(ii) JHNSA's receipt of any warning, notice, notice of violation, lawsuit or the like from any governmental agency or regulatory authority relating to environmental

compliance;

(iii) JHNSA's receipt of any complaint, claim, or lawsuit filed by any third party relating to environmental compliance; or

(iv) releases, spillage, leakage or disposal of any Hazardous Material at or on the Property.

(c) If JHNSA fails to comply with any of the provisions of this Section, the DIA and/or the City shall have the right, but shall not be obligated, to enter into and go upon the Property without thereby causing or constituting a termination of this License, or eviction of JHNSA, either constructive or otherwise, in whole or in part, from all or any portion of the Property, or an interference with JHNSA's possession and use of the Property, and take such steps and incur such expenses as the DIA or City shall deem necessary to correct JHNSA's default, including, without limitation of the generality of the foregoing, the making of all replacements or repairs for which JHNSA is responsible, and JHNSA shall reimburse the DIA and/or City, as applicable, on demand for any expense the DIA and/or City incurs as a result thereof.

16. Default. Each of the following events shall constitute a default hereunder by the DIA or JHNSA, as the case may be, and shall constitute a breach of this License:

(a) If JHNSA fails to pay the DIA any charge due hereunder as and when the same shall become payable after the DIA's written notice for payment; or

(b) If JHNSA shall fail to obtain and maintain during the License Term any applicable material licenses or permits; or

(c) If JHNSA shall fail to maintain the proper insurance as required by this License after having received written notice from the DIA or the City; or

(d) If JHNSA shall violate any term or condition of the Applicable Permits, the BSRA or Consent Order during the License Term; or

(e) If JHNSA fails to perform any of the covenants, conditions and terms of this License on JHNSA's part to be performed and such non-performance shall continue for a period of thirty (30) days after written notice thereof by the DIA to JHNSA; or if JHNSA shall fail to act in good faith to commence and undertake performance within such thirty (30) day period to cure a non-performance which cannot be cured within the initial thirty (30) day period unless JHNSA first designates in writing the reasonable time period to cure such non-performance and its intent to do so, or, JHNSA, having commenced to undertake such performance within the initial thirty (30) day period, shall fail to diligently proceed therewith to completion within the designated reasonable time period to cure such non-performance; or

(f) The occurrence of any one or more of the following events prior to the expiration of the License Term shall constitute an event of default hereunder: (i) a violation of any applicable and governing federal, state or local law, rule, regulation or policy with respect to the

subject matter hereof; (ii) if any representation or warranty contained in this License shall be false or misleading in any material respect; (iii) the application by JHNSA for, or consent to, the appointment of a receiver, trustee, liquidator or custodian (or similar official) of its or all or a substantial part of its assets, or if any party shall be unable or admit in writing its inability to pay its debts as they mature, make a general assignment for the benefit of creditors, be adjudicated a bankrupt or insolvent, file a voluntary petition in bankruptcy or a petition or answer seeking reorganization or any arrangement with creditors or agrees to take advantage of any insolvency law, file an answer admitting the material allegations of a petition filed against it in any bankruptcy, reorganization or insolvency proceeding or if any corporate action shall be taken by it for any purpose of effecting any of the foregoing, or if any order, judgment or decree shall be entered by a court of competent jurisdiction approving a petition seeking reorganization or appointing a receiver, trustee, liquidator or custodian (or other similar official) of any party hereto or of all or a substantial part of its assets, and such other judgment or decree shall continue unstayed and in effect for a period of thirty (30) consecutive days; or (iv) an event of default of JHNSA under any other agreement or transaction between JHNSA and the DIA or JHNSA and the City.

Any event of default under subsections 16(b) – (d) shall be deemed a material breach of this License and upon such default the DIA shall have the right to terminate and cancel the License immediately by providing written notice to JHNSA of the same. If any other event of default shall occur and remain uncured for a period of thirty (30) days, the DIA shall have the right to immediately terminate and cancel this License by giving to JHNSA written notice of such termination and cancellation. Upon such notice, this License shall terminate and the parties shall be released from all obligations under this License that do not specifically survive its termination. The foregoing remedy shall not be the exclusive remedy of the DIA for JHNSA's breach of this License. JHNSA, at its sole expense, shall have sixty (60) days from the effective termination date as provided in the written notice of termination to remove the Vessel and the Improvements from the Property. The City at its option may elect to retain title to the Improvements and shall provide written notice to JHNSA of the same at the same time and in the same manner as the written notice of termination and cancellation. JHNSA shall execute a quitclaim deed, bill of sale, and other documents reasonably requested by the City to evidence ownership of the Improvements in the City.

17. JHNSA Termination. JHNSA shall retain an absolute right to terminate and cancel this License at any time during the License Term in the event JHNSA determines that its financial condition and/or operating funds are not sufficient for JHNSA to maintain and operate the Ship Museum or the Property as described herein upon giving the DIA no less than ninety (90) days' written notice of JHNSA's need to terminate and cancel its obligations hereunder and designating the termination date. In such event, the License shall terminate and cease as of the effective date of JHNSA's termination hereunder (which in no event shall be less than ninety (90) days from the DIA's receipt of JHNSA's notice of termination) and the parties shall be released from all obligations hereunder which do not specifically survive termination; furthermore, all agreements, contracts or other rights with respect to the Property, the Ship Museum or the Improvements between JHNSA and other third parties in existence at the time of such termination shall terminate and cease as of the effective date of JHNSA's termination hereunder. JHNSA, at its sole expense, shall have sixty (60) days from the effective termination date as provided in the written notice to remove the Vessel and the Improvements from the Property. The City may elect to retain title to the

Improvements with written notice thereof provided to JHNSA consistent with the requirements of Section 16(f) hereof.

18. DIA Termination and Removal of Improvements. In addition to the DIA's termination rights outlined in Section 16 above, the DIA shall have the absolute right to terminate this License, at any time, by providing at least ninety (90) days' written notice of such termination to JHNSA. JHNSA, at its sole expense, shall have sixty (60) days from the effective termination date as provided in the written notice to remove the Vessel and the Improvements from the Property. As security for JHNSA's obligation to remove the Improvements and the Vessel upon termination of the License Agreement, JHNSA has transferred to the DIA _____, which amount represents the estimated costs of removal plus an additional ten (10%) pursuant to Section 6 of the Development Agreement executed by the parties dated _____ (the "**Removal Funds**"), to be held in an interest bearing DIA trust account during the License Term. All interest earned in the DIA trust account shall be rebated to JHNSA on an annual basis. In the event that JHNSA, upon termination of the License Agreement, fails to remove the Vessel and the Improvements, the DIA shall have the right, in addition to all other remedies available at law and in equity, to utilize the Removal Funds to effectuate removal of the Vessel and the Improvements. In the event the Removal Funds are not sufficient to cover the DIA's costs to remove the Vessel and the Improvements, then JHNSA shall, within thirty (30) days of receipt of the DIA's written demand, pay to the DIA any the difference between the Removal Funds and all costs and expenses the DIA incurred, including reasonable attorneys fees, in connection with removing the Improvements and the Vessel. Every fifth year during the License Term, JHNSA will provide the DIA a current cost estimate, certified by a licensed and insured towing company to be pre-approved by the City Engineer, for the costs to remove the Vessel and a current cost estimate to remove the Improvements agreed to by the City Engineer. In the event the DIA's trust account funds are less than one hundred and ten percent (110%) of the most recent certified Removal Costs, JHNSA shall immediately increase the Removal Funds held in the trust account to account for the difference. JHNSA's obligation in this Section 18 shall survive the termination or expiration of this License.

19. Licenses, Permits. JHNSA will be responsible for obtaining, in the name of the DIA, JHNSA or otherwise, all licenses, permits, inspections and other approvals necessary for the operation of the Ship Museum and Improvements on the Property, including but not limited to any occupational licenses necessary to operate the Ship Museum. The DIA shall cooperate with JHNSA in obtaining all such licenses, permits, inspections and other approvals, including, but not limited to, supplying information and executing applications, forms or other documents necessary for same. Any and all licenses, permits, inspections and other approvals shall be deemed to apply to JHNSA or its use of the Property in accordance with the covenants, conditions and terms of this License.

20. Subletting and Assignment. JHNSA shall not transfer, hypothecate, mortgage, pledge, assign or convey its interest in the License or sublet the Property or any part thereof without the approval of the City, the DIA and the Jacksonville City Council.

21. Expiration of Term. At the expiration of the License Term, JHNSA shall peaceably return to the City the Property in the original property condition as existed at the time of execution of this License, reasonable wear and tear excepted. JHNSA shall remove the Vessel and the Improvements in accordance with Section 18 above. It is understood and agreed between the DIA

and JHNSA that JHNSA shall have the right, at its sole expense, to remove from the Property all personal property of JHNSA situate at the Property, including, but not limited to, the Vessel, all furnishings, furniture, machinery, equipment, appurtenances and appliances placed or installed on the Property by same, provided JHNSA restores the Property after the removal therefrom. **[OGC – same issue, removal versus ownership.]**

22. DIA's/City's Right to Inspect. The DIA and City at all times may enter into and upon the Property for the purpose of inspecting same and/or for making improvements with prior written notice to JHNSA and, at JHNSA's option, accompanied by a JHNSA representative (except if not practical in the case of an emergency). JHNSA shall provide the DIA keys to all gates and improvements on the Property.

23. Sponsor/Donor Recognition, Advertising. Subject to applicable sign ordinances and approval of the Downtown Development Review Board, JHNSA may at its option designate the name of certain specific portions of the Ship Museum to recognize sponsors. Such names, and the graphics designating them, shall be appropriate and tasteful in accordance with practices by similar recreational and park facilities elsewhere in the United States. Such names and the graphics designating them shall be subject to the DIA's prior written approval. Notwithstanding anything herein to the contrary, no names, or the graphics designating them, shall promote or advertise alcohol or tobacco products. No such names or graphics shall be allowed on the Uplands Parcel.

24. DIA/City Recognition. All signage, and graphics for same, which advertise, designate or locate the Ship Museum shall further incorporate in its content, either in written type designation or logo designation, a recognition of the DIA and the City in reasonable form. All signage and banners for advertising, sponsorships and/or donors are excluded from this requirement. No signage making reference to the City of Jacksonville or the DIA shall be placed on or about the Property until such signage has been reviewed and approved by the DIA.

25. Force Majeure. If the DIA or JHNSA shall be delayed in, hindered in or prevented from the performance of any act required hereunder (other than performance requiring the payment of a sum of money) by reason of strikes, lockouts, epidemic, pandemic, labor troubles, protests, civil unrest, inability to procure materials, failure of power, restrictive governmental laws, regulations or actions, war, riots, insurrection, epidemic, pandemic, adverse weather conditions, the act, failure to act or default of the other party, or other reason beyond such party's reasonable control (excluding the unavailability of funds or financing), then the performance of such act shall be excused for the period of the delay and the period for the performance of any such act as required herein shall be extended for a period equivalent to the period of such delay.

26. Condemnation. If any part of the Property is taken by eminent domain or condemnation or voluntarily transferred to such authority under the threat thereof, the DIA may, at its sole option, terminate the License by giving written notice to JHNSA within thirty (30) days after the taking, or if by reason of such taking of the Property, JHNSA's operation on or access to the Property is substantially and materially impaired, JHNSA shall have the option to terminate this License by giving written notice to the DIA within thirty (30) days after the taking. JHNSA hereby waives any and all rights it may have in all condemnation awards, including, without limitation, loss of or damage to its License, and hereby assigns said claims to the DIA, except such awards as are

City Hall at St. James
117 West Duval Street, Suite 310
Jacksonville, Florida 32202

With copy to: Office of General Counsel
Attention: Corporation Secretary
117 West Duval Street, Suite 480
Jacksonville, Florida 32202

If to JHNSA: Jacksonville Historic Naval Ship Association, Inc.
Attention: Justin Weakland
2 Independent Drive, Suite 1414
Jacksonville, FL 32202

With copy to: Abel Bean Law P.A.
100 N. Laura Street, Suite 501
Jacksonville, FL 32202
Attn: Daniel K. Bean

or such other address either party from time to time may specify in writing to the other.

(b) Legal Representation. Each respective party to this License has been represented by counsel in the negotiation of this License and, accordingly, no provision of this License shall be construed against a respective party due to the fact that it or its counsel drafted, dictated or modified this License or any covenant, condition or term thereof.

(c) Further Instruments. Each respective party hereto shall, from time to time, execute and deliver such further instruments as any other party or parties or its counsel may reasonably request to effectuate the intent of this License.

(d) Severability of Invalid Provision. If any one or more of the agreements, provisions, covenants, conditions and terms of the License shall be contrary to any express provision of law or contrary to the policy of express law, though not expressly prohibited, or against public policy, or shall for any reason whatsoever be held invalid, then such agreements, provisions, covenants, conditions or terms shall be null and void with no further force or effect and shall be deemed separable from the remaining agreements, provisions, covenants, conditions and terms of the License and shall in no way affect the validity of any of the other provisions hereof.

(e) No Personal Liability. No representation, statement, covenant, warranty, stipulation, obligation or agreement contained herein shall be deemed to be a representation, statement, covenant, warranty, stipulation, obligation or agreement of any member, officer, employee or agent of the City, DIA or JHNSA in his or her individual capacity and none of the foregoing persons shall be liable personally or be subject to any personal liability or accountability by reason of the execution or delivery thereof.

(f) Third Party Beneficiaries. Nothing herein express or implied is intended or shall be construed to confer upon any entity other than the City, DIA and JHNSA any right, remedy

or claim, equitable or legal, under and by reason of this License or any provision hereof, all provisions, conditions and terms hereof being intended to be and being for the exclusive and sole benefit of the City, DIA and JHNSA.

(g) Successors and Assigns. To the extent permitted by Section 20, this License shall be binding upon and inure to the benefit of the parties hereto and their respective heirs, successors and assigns.

(h) Survival of Representations and Warranties. The respective indemnifications, representations and warranties of the respective parties to this License shall survive the expiration or termination of the License and remain in effect.

(i) Governing Law and Venue. This License shall be governed by and construed in accordance with the laws of the State of Florida and the Ordinances of the City of Jacksonville. Wherever possible, each provision, condition and term of this License shall be interpreted in such manner as to be effective and valid under applicable law; but if any provision, condition or term of this License, or any documentation executed and delivered hereto, shall be prohibited by or invalid under such applicable law, then such provision, condition or term shall be ineffective to the extent of such prohibition or invalidity without invalidating the remainder of such provision, condition or term or the remaining provisions, conditions and terms of this License or any documentation executed and delivered pursuant hereto. JHNSA acknowledges, consents and agrees that all legal actions or proceedings arising out of or related to this License shall lie exclusively in a state court in Duval County, Florida.

(j) Section Headings. The section headings inserted in this License are for convenience only and are not intended to and shall not be construed to limit, enlarge or affect the scope or intent of this License, nor the meaning of any provision, condition or term hereof.

(k) Counterparts. This License may be executed in two (2) or more counterparts, each of which shall be deemed an original, but all of which together shall constitute one (1) and the same document.

(l) Entire Agreement. This License contains the entire agreement between the respective parties hereto and supersedes any and all prior agreements and understandings between the respective parties hereto relating to the subject matter hereof. No statement or representation of the respective parties hereto, their agents or employees, made outside of this License, and not contained herein, shall form any part hereof or bind any respective party hereto. This License shall not be supplemented, amended or modified except by written instrument signed by the respective parties hereto.

(m) Attorney's Fees and Costs. In any litigation arising out of or pertaining to this License, each party shall be responsible for their own attorney's fees and costs, whether incurred before, during or after trial, or upon any appellate level.

(n) Time. Time is of the essence for this License. When any time period specified herein falls upon a Saturday, Sunday or legal holiday, the time period shall be extended to

5:00 P.M. on the next ensuing business day.

(o) Waiver of Defaults. The waiver by either party of any breach of this License by the other party shall not be construed as a waiver of any subsequent breach of any duty or covenant imposed by this License.

[The remainder of this page was intentionally left blank. Signature pages to follow.]

IN WITNESS WHEREOF, the respective parties hereto have hereunto executed this License for the purposes expressed herein effective the day and year first above written.

**DOWNTOWN INVESTMENT
AUTHORITY** on behalf of the CITY OF
JACKSONVILLE, a Florida municipal
corporation

By: _____
Lori Boyer, CEO

WITNESSES:

**JACKSONVILLE HISTORIC NAVAL
SHIP ASSOCIATION, INC.**, a Florida non-
profit corporation

Print Name: _____

By: _____
Print Name: _____
Title: _____

Print Name: _____

Form Approved:

Office of General Counsel

GC-#1339971-v13-JHNSA_USS_Orleck_License_Agreement.DOC

EXHIBIT A

THE PROPERTY LEGAL DESCRIPTION

(Submerged Lands Area, Pier 1 and Uplands Area to be inserted at time of License execution.)

EXHIBIT B
APPROVED PLANS

The Approved Plans shall be submitted by JHNSA and approved by the DIA in accordance with Section 8(a) herein.

EXHIBIT C-1

APPROVED SCOPE OF WORK

The Approved Scope of Work shall be submitted by JHNSA and approved by the DIA in accordance with Section 8(a) herein.

EXHIBIT C-2

PROJECT BUDGET

The Project Budget shall be submitted by JHNSA and reviewed by the DIA in accordance with Section 8(a) herein.

EXHIBIT D
PERFORMANCE SCHEDULE

[To be provided prior to execution of this License.]

EXHIBIT E

PROJECT SOURCES OF USES AND FUNDS

[To be provided prior to execution of this License.]

EXHIBIT F

PERMITTED USES

- Operate and maintain a Ship Museum;
- Host overnight camp-aboard activities;
- Host community events and concerts;
- Host children's activities and educational programs;
- Host military, holiday, and private ceremonies and events; and
- Host fundraising events.

EXHIBIT G INDEMNIFICATION

JHNSA, its contractors, subcontractors, consultants and agents (as applicable) (collectively, the “Indemnifying Parties”) shall hold harmless, indemnify, and defend the DIA, City and their respective members, officers, officials, employees and agents (collectively the “Indemnified Parties”) from and against, without limitation, any and all claims, suits, actions, losses, damages, injuries, liabilities, fines, penalties, costs and expenses of whatsoever kind or nature, which may be incurred by, charged to or recovered from any of the foregoing Indemnified Parties for:

1. General Tort Liability, for any negligent act, error or omission, recklessness or intentionally wrongful conduct on the part of the Indemnifying Parties that causes injury (whether mental or corporeal) to persons (including death) or damage to property, whether arising out of or incidental to the Indemnifying Parties’ performance of the obligations, operations, services or work performed hereunder; and

2. Environmental Liability, to the extent this License contemplates environmental exposures, arising from or in connection with any environmental, health and safety liabilities, claims, citations, clean-up or damages whether arising out of or relating to the operation or other activities performed in connection with the License; and

3. Intellectual Property Liability, to the extent this License contemplates intellectual property exposures, arising directly or indirectly out of any allegation that the services provided hereunder, any product generated by said services, or any part of the services as contemplated in this License, constitutes an infringement of any copyright, patent, trade secret or any other intellectual property right. If in any suit or proceeding, the services provided hereunder, or any product generated by said services, is held to constitute an infringement and its use is permanently enjoined, the Indemnifying Parties shall, immediately, make every reasonable effort to secure within sixty (60) days, for the Indemnified Parties a license, authorizing the continued use of the service or product. If the Indemnifying Parties fail to secure such a license for the Indemnified Parties, then the Indemnifying Parties shall replace the service or product with a non-infringing service or product or modify such service or product in a way satisfactory to Buyer, so that the service or product is non-infringing.

If an Indemnifying Party exercises its rights under this License, the Indemnifying Party will (1) provide reasonable notice to the Indemnified Parties of the applicable claim or liability, and (2) allow the Indemnified Parties, at their own expense, to participate in the litigation of such claim or liability to protect their interests. **The scope and terms of the indemnity obligations herein described are separate and apart from, and shall not be limited by any insurance provided pursuant to this License or otherwise. Such terms of indemnity shall survive the expiration or termination of this License.**

In the event that any portion of the scope or terms of this indemnity is in derogation of Section 725.06 or 725.08 of the Florida Statutes, all other terms of this indemnity shall remain in full force and effect. Further, any term which offends Section 725.06 or 725.08 of the Florida Statutes will be modified to comply with said statutes.

**EXHIBIT H
INSURANCE REQUIREMENTS**

Insurance Requirements for Construction Activities:

Without limiting its liability under this License, **JHNSA** shall at all times during the term of this License procure prior to commencement of any work and maintain at its sole expense during the License term (and **JHNSA** shall require its contractors, subcontractors, laborers, materialmen and suppliers to provide, as applicable), insurance of the types and limits not less than amounts stated below:

Insurance Coverages

Schedule	Limits
Worker’s Compensation Employer’s Liability	Florida Statutory Coverage \$ 1,000,000 Each Accident \$ 1,000,000 Disease Policy Limit \$ 1,000,000 Each Employee/Disease

This insurance shall cover **JHNSA** (and, to the extent they are not otherwise insured, its contractors and subcontractors) for those sources of liability which would be covered by the latest edition of the standard Workers’ Compensation policy, as filed for use in the State of Florida by the National Council on Compensation Insurance (NCCI), without any restrictive endorsements other than the Florida Employers Liability Coverage Endorsement (NCCI Form WC 09 03), those which are required by the State of Florida, or any restrictive NCCI endorsements which, under an NCCI filing, must be attached to the policy (i.e., mandatory endorsements). In addition to coverage for the Florida Workers’ Compensation Act, where appropriate, coverage is to be included for the Federal Employers’ Liability Act, USL&H and Jones, and any other applicable federal or state law.

Commercial General Liability	\$2,000,000 General Aggregate \$2,000,000 Products & Comp. Ops. Agg. \$1,000,000 Personal/Advertising Injury \$1,000,000 Each Occurrence \$ 50,000 Fire Damage \$ 5,000 Medical Expenses
-------------------------------------	---

Such insurance shall be no more restrictive than that provided by the most recent version of the standard Commercial General Liability Form (ISO Form CG 00 01) as filed for use in the State of Florida without any restrictive endorsements other than those reasonably required by the DIA’s Office of Insurance and Risk Management. An Excess Liability policy or Umbrella policy can be used to satisfy the above limits.

Automobile Liability (Coverage for all automobiles, owned, hired or non-owned used in performance of the Contract)	\$1,000,000 Combined Single Limit
--	-----------------------------------

Such insurance shall be no more restrictive than that provided by the most recent version of the standard Business Auto Coverage Form (ISO Form CA0001) as filed for use in the State of Florida without any restrictive endorsements other than those which are required by the State of Florida, or equivalent manuscript form, must be attached to the policy equivalent endorsement as filed with ISO (i.e., mandatory endorsement).

Design Professional Liability \$5,000,000 per Claim and Aggregate

Any entity hired to perform professional services as a part of this License shall maintain professional liability coverage on an Occurrence Form or a Claims Made Form with a retroactive date to at least the first date of this Contract. If provided on a Claim Made Form, the coverages must respond to all claims reported within three years following the period for which coverage is required and which would have been covered had the coverage been on an occurrence basis.)

Builders Risk/ Installation Floater %100 Completed Value of the Project

Such insurance shall be on a form acceptable to the City's Office of Insurance and Risk Management. The Builder's Risk policy shall include the SPECIAL FORM/ALL RISK COVERAGES. The Builder's Risk and/or Installation policy shall not be subject to a coinsurance clause. A maximum \$10,000 deductible for other than windstorm and hail. For windstorm and hail coverage, the maximum deductible applicable shall be 2% of the completed value of the project. Named insured's shall be: the CONTRACTOR, the CITY, DIA and their respective members, officials, employees and agents, the ENGINEER, and the PROGRAM MANAGEMENT FIRM(S) (when program management services are provided). The DIA of Jacksonville, its members, officials, officers, employees and agents are to be named as a loss payee.

Pollution Liability \$1,000,000 per Loss
\$2,000,000 Annual Aggregate

Any entity hired to perform services as part of this License for environmental or pollution related concerns shall maintain Contractor's Pollution Liability coverage. Such Coverage will include bodily injury, sickness, and disease, mental anguish or shock sustained by any person, including death; property damage including physical injury to destruction of tangible property including resulting loss of use thereof, cleanup costs, and the loss of use of tangible property that has not been physically injured or destroyed; defense including costs charges and expenses incurred in the investigation, adjustment or defense of claims for such compensatory damages; coverage for losses caused by pollution conditions that arises from the operations of the contractor including transportation.

Pollution Legal Liability \$1,000,000 per Loss
\$2,000,000 Aggregate

Any entity hired to perform services as a part of this License that require disposal of any hazardous material off the job site shall maintain Pollution Legal Liability with coverage for bodily injury and property damage for losses that arise from the facility that is accepting the waste under this License.

Watercraft Liability \$1,000,000 Per Occurrence
(to the extent that watercraft is utilized in the services of this License)

Umbrella Liability \$5,000,000 Each Occurrence/ Aggregate.

The Umbrella Liability policy shall be in excess of the above limits without any gap. The Umbrella coverage will follow-form the underlying coverages and provides on an Occurrence basis all coverages listed above and shall be included in the Umbrella policy

Additional Insurance Provisions

- A. **Additional Insured:** All insurance except Worker's Compensation and Professional Liability shall be endorsed to name the DIA, the DIA of Jacksonville and DIA's members, officials, officers, employees and agents as Additional Insured. Additional Insured for General Liability shall be in a form no more restrictive than CG2010 and CG2037, Automobile Liability CA2048.
- B. **Waiver of Subrogation.** All required insurance policies shall be endorsed to provide for a waiver of underwriter's rights of subrogation in favor of DIA, the DIA of Jacksonville and its members, officials, officers employees and agents.
- C. **JHNSA's Insurance Primary.** The insurance provided by **JHNSA** shall apply on a primary basis to, and shall not require contribution from, any other insurance or self-insurance maintained by the DIA or any DIA members, officials, officers, employees and agents.
- D. **Deductible or Self-Insured Retention Provisions.** All deductibles and self-insured retentions associated with coverages required for compliance with this License shall remain the sole and exclusive responsibility of the named insured **JHNSA**. Under no circumstances will DIA, the City of Jacksonville or their respective members, officers, directors, employees, representatives, and agents be responsible for paying any deductible or self-insured retentions related to this License.
- E. **JHNSA's Insurance Additional Remedy.** Compliance with the insurance requirements of this License shall not limit the liability of **JHNSA** or its contractors, subcontractors, employees or agents to the DIA, the City or others. Any remedy provided to the City, the DIA or their respective members, officials, officers, employees or agents shall be in addition to and not in lieu of any other remedy available under this License or otherwise.
- F. **Waiver/Estoppel.** Neither approval by the DIA nor failure to disapprove the insurance furnished by **JHNSA** shall relieve **JHNSA** of **JHNSA's** full responsibility to provide insurance as required under this License.
- G. **Certificates of Insurance.** **JHNSA** shall provide the DIA Certificates of Insurance that shows the corresponding DIA Contract Number in the description, if known, Additional Insureds as

provided above and waivers of subrogation. The certificates of insurance shall be mailed to the DIA of Jacksonville (Attention: Chief of Risk Management), 117 W. Duval Street, Suite 335, Jacksonville, Florida 32202.

- H. Carrier Qualifications. The above insurance shall be written by an insurer holding a current certificate of authority pursuant to chapter 624, Florida State or a company that is declared as an approved Surplus Lines carrier under Chapter 626 Florida Statutes. Such insurance shall be written by an insurer with an A.M. Best Rating of A- VII or better.
- I. Notice. **JHNSA** shall provide an endorsement issued by the insurer to provide the DIA thirty (30) days prior written notice of any change in the above insurance coverage limits or cancellation, including expiration or non-renewal. If such endorsement is not provided, **JHNSA** shall provide said a thirty (30) days' written notice of any change in the above coverages or limits, coverage being suspended, voided, cancelled, including expiration or non-renewal.
- J. Survival. Anything to the contrary notwithstanding, the liabilities of **JHNSA** under this License shall survive and not be terminated, reduced or otherwise limited by any expiration or termination of insurance coverage.
- K. Additional Insurance. Depending upon the nature of any aspect of any project and its accompanying exposures and liabilities, the DIA may reasonably require additional insurance coverages in amounts responsive to those liabilities, which may or may not require that the DIA and the DIA also be named as an additional insured.
- L. Special Provisions: Prior to executing this License, **JHNSA** shall present this License and Exhibits G & H to its insurance agent affirming that: 1) the agent has personally reviewed the insurance requirements of the License, and (2) the agent is capable (has proper market access) to provide the coverages and limits of liability required on behalf of **JHNSA**.

EXHIBIT I
Insurance Requirements for Operation Activities:

Without limiting its liability under this License, **JHNSA** shall at all times during the term of this License procure prior to commencement of work and maintain at its sole expense during the life of this License (and **JHNSA** shall require its, contractors, subcontractors, laborers, materialmen and suppliers to provide, as applicable), insurance of the types and limits not less than amounts stated below:

Insurance Coverages

Schedule	Limits
Worker's Compensation Employer's Liability	Florida Statutory Coverage \$ 100,000 Each Accident \$ 500,000 Disease Policy Limit \$ 100,000 Each Employee/Disease

This insurance shall cover **JHNSA** (and, to the extent they are not otherwise insured, its subcontractors) for those sources of liability which would be covered by the latest edition of the standard Workers' Compensation policy, as filed for use in the State of Florida by the National Council on Compensation Insurance (NCCI), without any restrictive endorsements other than the Florida Employers Liability Coverage Endorsement (NCCI Form WC 09 03), those which are required by the State of Florida, or any restrictive NCCI endorsements which, under an NCCI filing, must be attached to the policy (i.e., mandatory endorsements). In addition to coverage for the Florida Workers' Compensation Act, where appropriate, coverage is to be included for the Federal Employers' Liability Act, USL&H and Jones, and any other applicable federal or state law.

Commercial General Liability	\$2,000,000 General Aggregate \$2,000,000 Products & Comp. Ops. Agg. \$1,000,000 Personal/Advertising Injury \$1,000,000 Each Occurrence \$ 50,000 Fire Damage \$ 5,000 Medical Expenses
-------------------------------------	--

Such insurance shall be no more restrictive than that provided by the most recent version of the standard Commercial General Liability Form (ISO Form CG 00 01) as filed for use in the State of Florida without any restrictive endorsements other than those reasonably required by the DIA's Office of Insurance and Risk Management. An Excess Liability policy or Umbrella policy can be used to satisfy the above limits.

Vessel Pollution Liability, Pollution Liability, Pollution Legal Liability (when transportation of pollutants is included in the Work).

All Pollution Coverages shall include clean-up cost	\$5,000,000 per Occurrence \$5,000,000 General Aggregate
---	---

Protection & Indemnity (P&I) and Marine General Liability \$5,000,000 per occurrence

Automobile Liability \$1,000,000 Combined Single Limit
(Coverage for all automobiles, owned, hired or non-owned used in performance of this License)

Such insurance shall be no more restrictive than that provided by the most recent version of the standard Business Auto Coverage Form (ISO Form CA0001) as filed for use in the State of Florida without any restrictive endorsements other than those which are required by the State of Florida, or equivalent manuscript form, must be attached to the policy equivalent endorsement as filed with ISO (i.e., mandatory endorsement).

Liquor or Host Liquor Liability \$1,000,000 Each Occurrence
(Liquor or Host Liquor Liability to the extent liquor is being sold, served or consumed.)

Sexual Molestation \$1,000,000 Per Claim
\$2,000,000 Aggregate

(Only if program includes direct supervision of children, special needs, and/or senior citizens)

Sexual Molestation Liability coverage will be provided on an Occurrence Form or a Claims Made Form with a retroactive date to at least the first date of this License. If provided on a Claim Made Form, the coverages must respond to all claims reported within three years following the period for which coverage is required and which would have been covered had the coverage been on an occurrence basis.

Bumbershoot Liability \$5,000,000 Each Occurrence/ Aggregate.

The Bumbershoot Liability policy shall be in excess of the above limits without any gap. The Umbrella coverage will follow-form the underlying coverages and provides on an Occurrence basis all coverages listed above and shall be included in the Bumbershoot policy

Additional Insurance Provisions

M. Additional Insured: All insurance except Worker's Compensation shall be endorsed to name the DIA, the City of Jacksonville and DIA's members, officials, officers, employees and agents as Additional Insured. Additional Insured for General Liability shall be in a form no more restrictive than CG2010 and CG2037, Automobile Liability CA2048.

N. Waiver of Subrogation. All required insurance policies shall be endorsed to provide for a waiver of underwriter's rights of subrogation in favor of the DIA, the City of Jacksonville and its members, officials, officers employees and agents.

- O. JHNSA's Insurance Primary. The insurance provided by **JHNSA** shall apply on a primary basis to, and shall not require contribution from, any other insurance or self-insurance maintained by the DIA, the City or any of their respective members, officials, officers, employees and agents.
- P. Deductible or Self-Insured Retention Provisions. All deductibles and self-insured retentions associated with coverages required for compliance with this License shall remain the sole and exclusive responsibility of the named insured **JHNSA**. Under no circumstances will the DIA or the City of Jacksonville or their respective its members, officers, directors, employees, representatives, and agents be responsible for paying any deductible or self-insured retentions related to this License.
- Q. JHNSA's Insurance Additional Remedy. Compliance with the insurance requirements of this License shall not limit the liability of **JHNSA** or its contractors, subcontractors, employees or agents to the DIA or others. Any remedy provided to the DIA, City or their respective members, officials, officers, employees or agents shall be in addition to and not in lieu of any other remedy available under this License or otherwise.
- R. Waiver/Estoppel. Neither approval by the DIA nor failure to disapprove the insurance furnished by **JHNSA** shall relieve **JHNSA** of **JHNSA**'s full responsibility to provide insurance as required under this License.
- S. Certificates of Insurance. **JHNSA** shall provide the DIA Certificates of Insurance that show the corresponding DIA Contract Number in the Description, if known, Additional Insureds as provided above and waivers of subrogation. The certificates of insurance shall be mailed to the DIA of Jacksonville (Attention: Chief of Risk Management), 117 W. Duval Street, Suite 335, Jacksonville, Florida 32202.
- T. Carrier Qualifications. The above insurance shall be written by an insurer holding a current certificate of authority pursuant to chapter 624, Florida State or a company that is declared as an approved Surplus Lines carrier under Chapter 626 Florida Statutes. Such Insurance shall be written by an insurer with an A.M. Best Rating of A- VII or better.
- U. Notice. **JHNSA** shall provide an endorsement issued by the insurer to provide the DIA thirty (30) days' prior written notice of any change in the above insurance coverage limits or cancellation, including expiration or non-renewal. If such endorsement is not provided, **JHNSA** shall provide said a thirty (30) days' written notice of any change in the above coverages or limits, coverage being suspended, voided, cancelled, including expiration or non-renewal.
- V. Survival. Anything to the contrary notwithstanding, the liabilities of **JHNSA** under this License shall survive and not be terminated, reduced or otherwise limited by any expiration or termination of insurance coverage.
- W. Additional Insurance. Depending upon the nature of any aspect of any project and its accompanying exposures and liabilities, the DIA may reasonably require additional insurance coverages in amounts responsive to those liabilities, which may or may not require that the DIA also be named as an additional insured.

X. Special Provisions: Prior to executing this Agreement, **JHNSA** shall present this License and Exhibits G & H to its insurance agent affirming that: 1) the agent has personally reviewed the insurance requirements of this License, and (2) the agent is capable (has proper market access) to provide the coverages and limits of liability required on behalf of **JHNSA**.

EXHIBIT I

APPLICABLE PERMITS

[To be provided prior to execution of this License.]